

LOPO® 乐普陶板
Terracotta Facade Panels

陶土專家 用心制陶

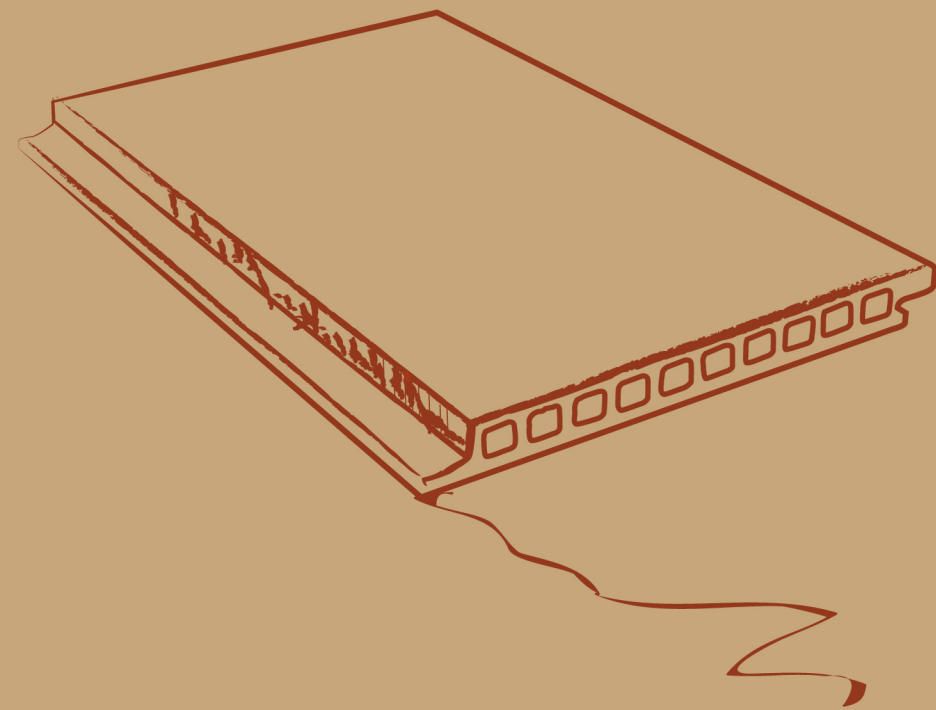

福建省乐普陶板制造有限公司

FUJIAN LOPO TERRACOTTA PANELS MANUFACTURING CO., LTD.

地址：福建省长泰县古农银塘工业区

Add: Yintang Industrial Zone, Gunong, Changtai, Fujian Province

E-mail: lopo@lopochina.com

Tel: +86 159 6081 0759

Fax: +86 592 3778925

www.lopochina.com

技术手册
Technical Brochure

目录

CONTENTS

01 / 03	配件 Fitting
04 / 31	18mm陶板系统安装方案 18mm terracotta panels mounting system
05 / 15	18mm短悬臂陶板系统安装节点图
16 / 18	18mm短横梁陶板系统(1)安装节点图
19 / 20	18mm短横梁陶板系统(2)安装节点图
21 / 28	18mm横滑紧定式竖向系统安装节点图
29 / 31	18mm背栓式竖向系统安装节点图
32 / 54	30mm陶板系统安装方案 30mm terracotta panels mounting system
33 / 42	30mm横向陶板系统(1)安装节点图
43 / 44	30mm横向陶板系统(2)安装节点图
45 / 54	30mm竖向陶板系统安装节点图
55 / 58	21mm陶板系统安装方案 21mm terracotta panels mounting system
59 / 71	湿贴陶板系统安装方案 Terracotta tiles system
60 / 65	9mm湿贴陶板挂贴系统安装节点图
66 / 71	11mm湿贴陶板挂贴系统安装节点图
72 / 78	陶管系统安装方案 Terracotta sticks mounting system
73 / 74	50x50陶管系统(1)安装节点图
75 / 76	50x50陶管系统(2)安装节点图
77	50x50陶管系统(3)安装节点图
78 / 80	38x80陶管系统安装节点图
81 / 83	40x85陶管系统安装节点图
84 / 85	60x60陶管系统安装节点图

序号	编号	截面	图片	序号	编号	截面	图片
1	T18挂件 LPXC-01			12	T18收口挂件 LPXC-12		
2	T18挂件 LPXC-02			13	背栓用挂件 LPXC-13		
3	T18挂件 LPXC-03			14	背栓用挂件 LPXC-14		
4	T18挂件 LPXC-04			15	T30挂件 LPXC-15		
5	T18挂件 LPXC-05			16	角码 LPXC-16		
6	T18挂件 LPXC-06			17	垫片 LPXC-17		
7	T18挂件 LPXC-07			18	T30挂件 LPXC-18		
8	T18挂件 LPXC-08			19	T30收口挂件 LPXC-19		
9	T18挂件 LPXC-09			20	T30挂件 LPXC-20		
10	T18竖挂板挂件 LPXC-10			21	角码 LPXC-21		
11	T18收口挂件 LPXC-11			22	垫片 LPXC-22		

序号	编号	截面	图片	序号	编号	截面	图片
23	T30挂件 LPXC-23			28	八字型挂件 LPXC-28		
24	垫片 LPXC-24			29	湿贴板挂件 LPXC-29		
25	T21挂件 LPXC-25			30	陶管卡接件 LPXC-30		
26	T21收口挂件 LPXC-26			31	陶管卡接件 LPXC-31		
27	角码 LPXC-27			32	陶管插芯 LPXC-32		

序号	编号	截面	图片	序号	编号	截面	图片
33	短横梁 LPXC-Z01			37	短横梁 LPXC-Z05		
34	角码 LPXC-Z02			38	短横梁 LPXC-Z06		
35	短横梁 LPXC-Z03			39	短横梁 LPXC-Z07		
36	短横梁配件 LPXC-Z04			40	竖挂板转接件 LPXC-Z08		

序号	编号	截面	图片	序号	编号	截面	图片
41	垫片 LPXC-Z09			46	收口短横梁 LPXC-Z14		
42	短悬臂 LPXC-Z10			47	收口短横梁 LPXC-Z15		
43	短悬臂 LPXC-Z11			48	铝角码 LPXC-Z16		
44	收口短横梁 LPXC-Z12			49	铝合金竖料 LPXC-17		
45	收口短横梁 LPXC-Z13						

序号	编号	截面	图片	序号	编号	截面	图片
50	EPDM胶条 LPJT-01			53	EPDM胶条 LPJT-04		
51	EPDM胶条 LPJT-02			54	EPDM胶条 LPJT-05		
52	EPDM胶条 LPJT-03			55	PVC卡座 LPJT-06		

18mm
陶板系统安
装方案
18mm terracotta panels
mounting system

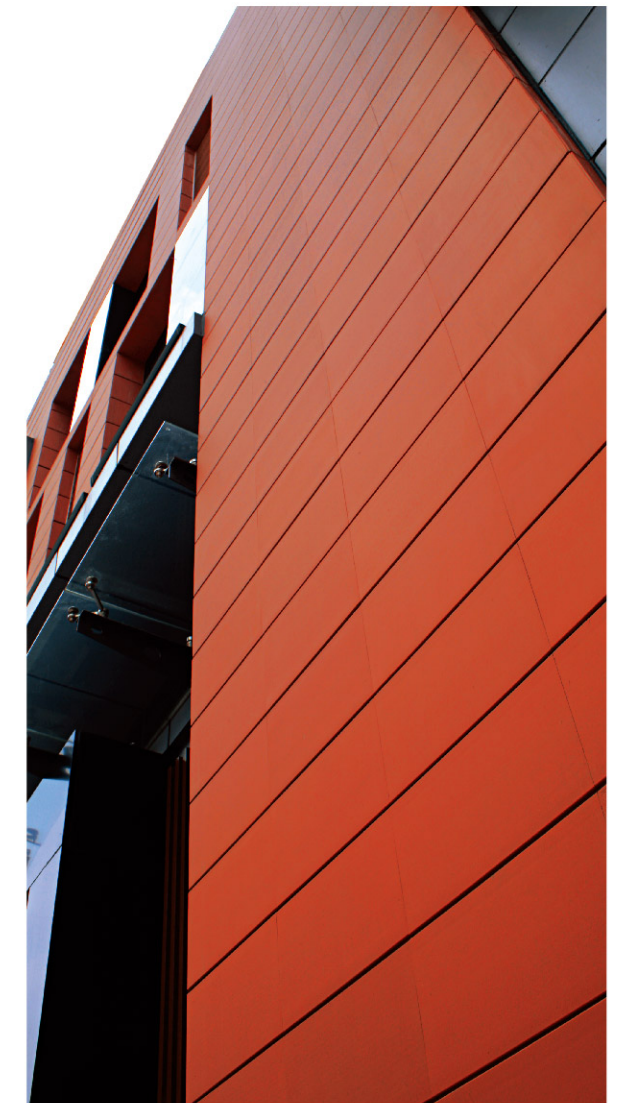

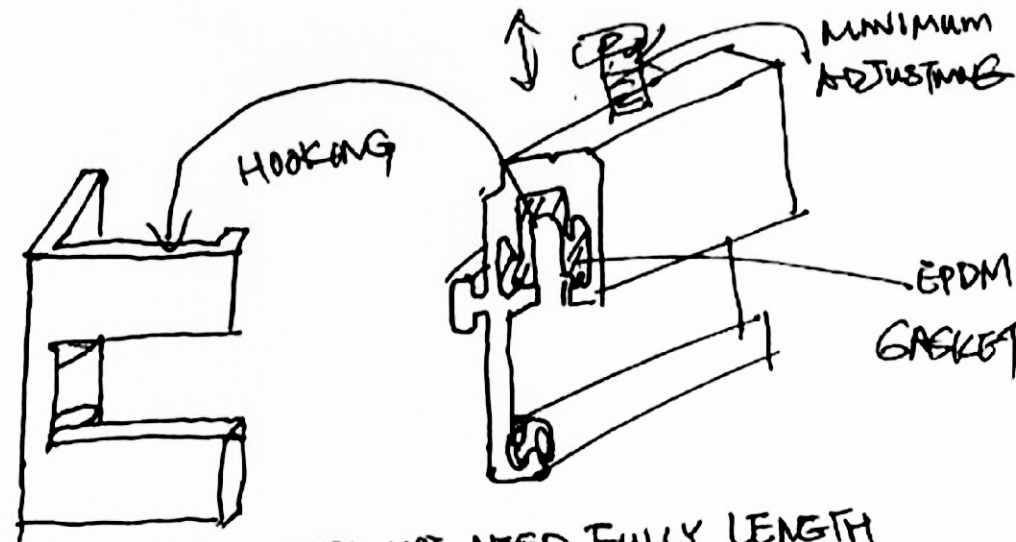

THIS SYSTEM DOES NOT NEED FULLY LENGTH HORIZONTAL TRANSOM, ONLY THIS SHORT HOOK BRACKET TO ARCHIVE CLIENTS' COST REQUIREMENT.

1.

18mm 短悬臂陶板系统安装节点图

1.

18mm 短悬臂陶板系统安装节点图

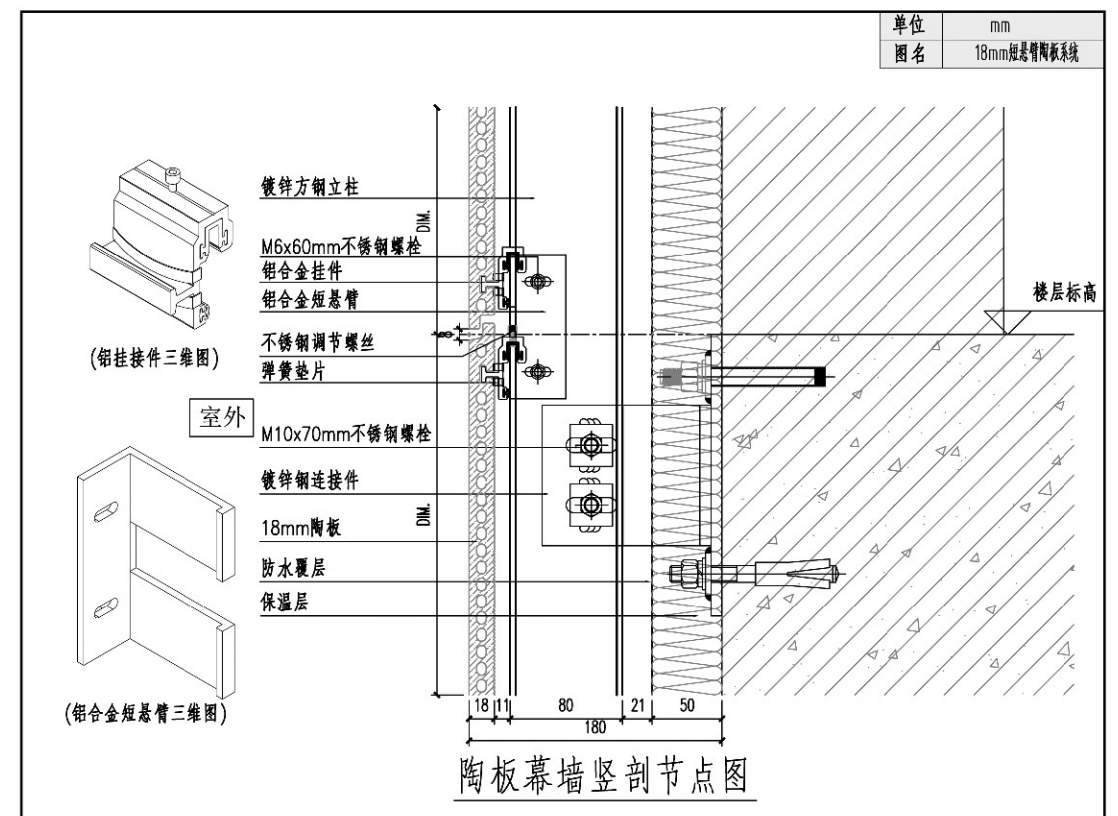
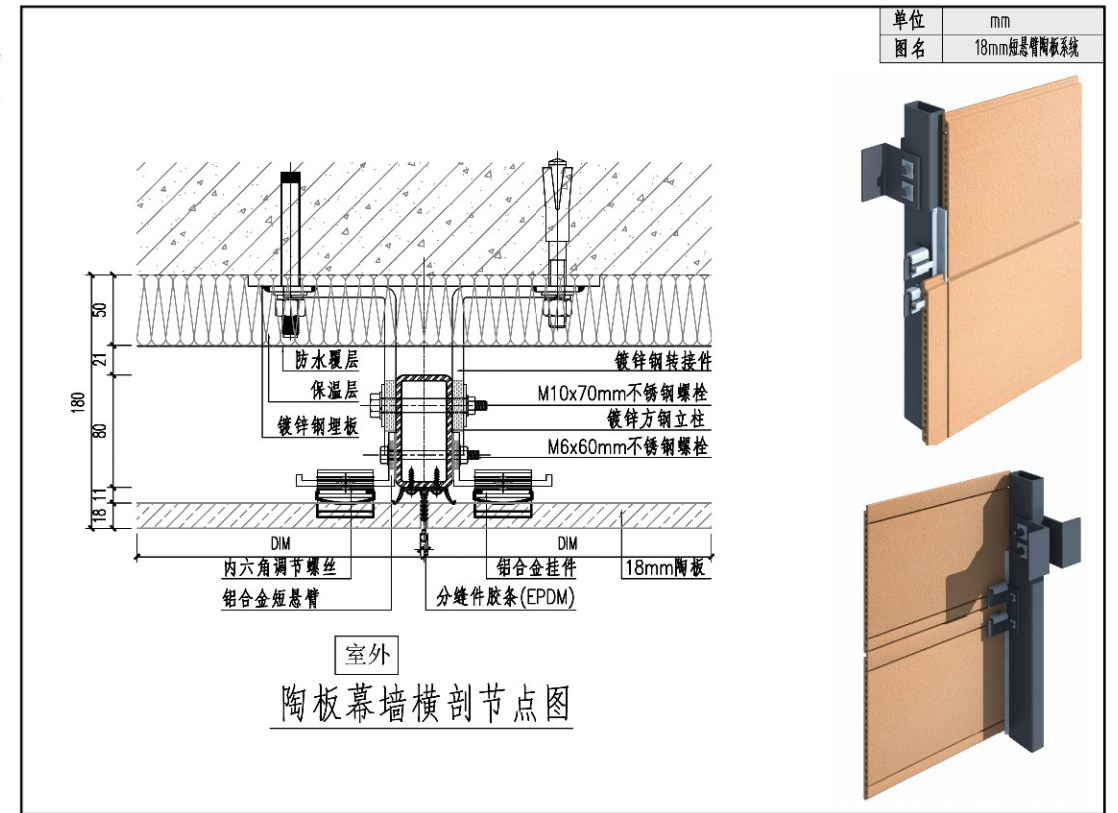

1.
18mm
短悬臂陶板系
统安装节点图

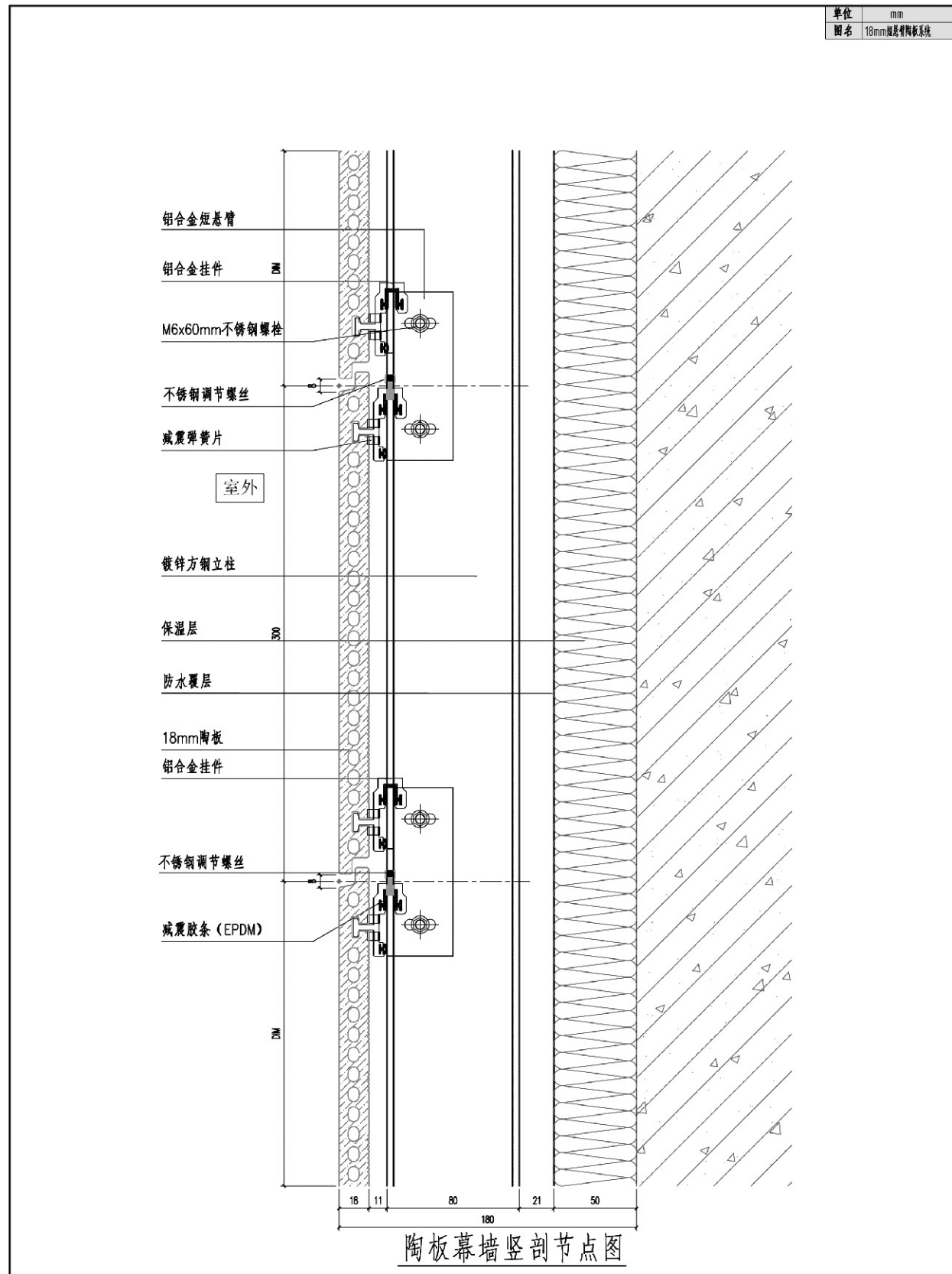

1.
18mm
短悬臂陶板系
统安装节点图

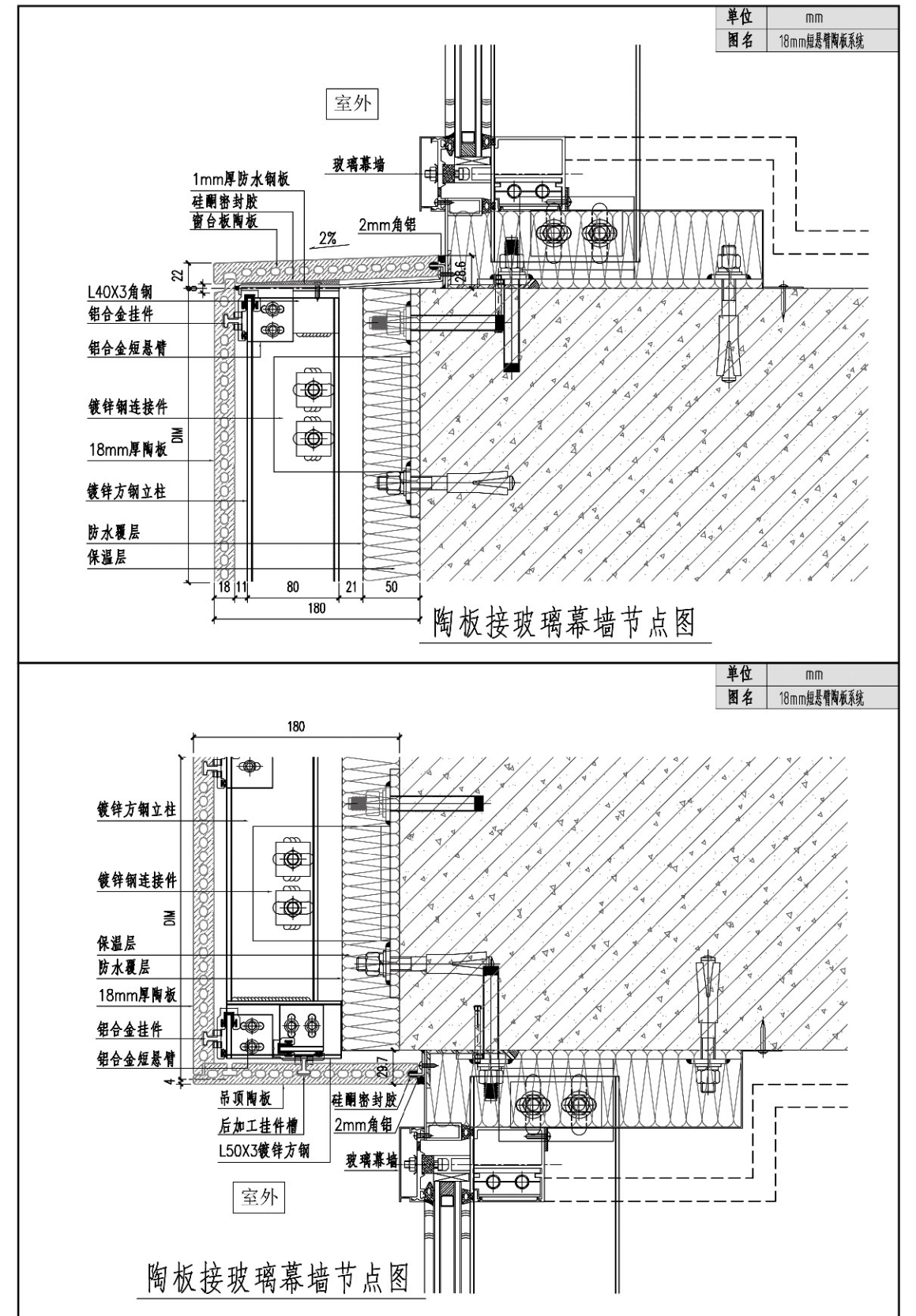

单位 mm
图名 18mm短悬臂陶板系统

1.
18mm
短悬臂陶板系
统安装节点图

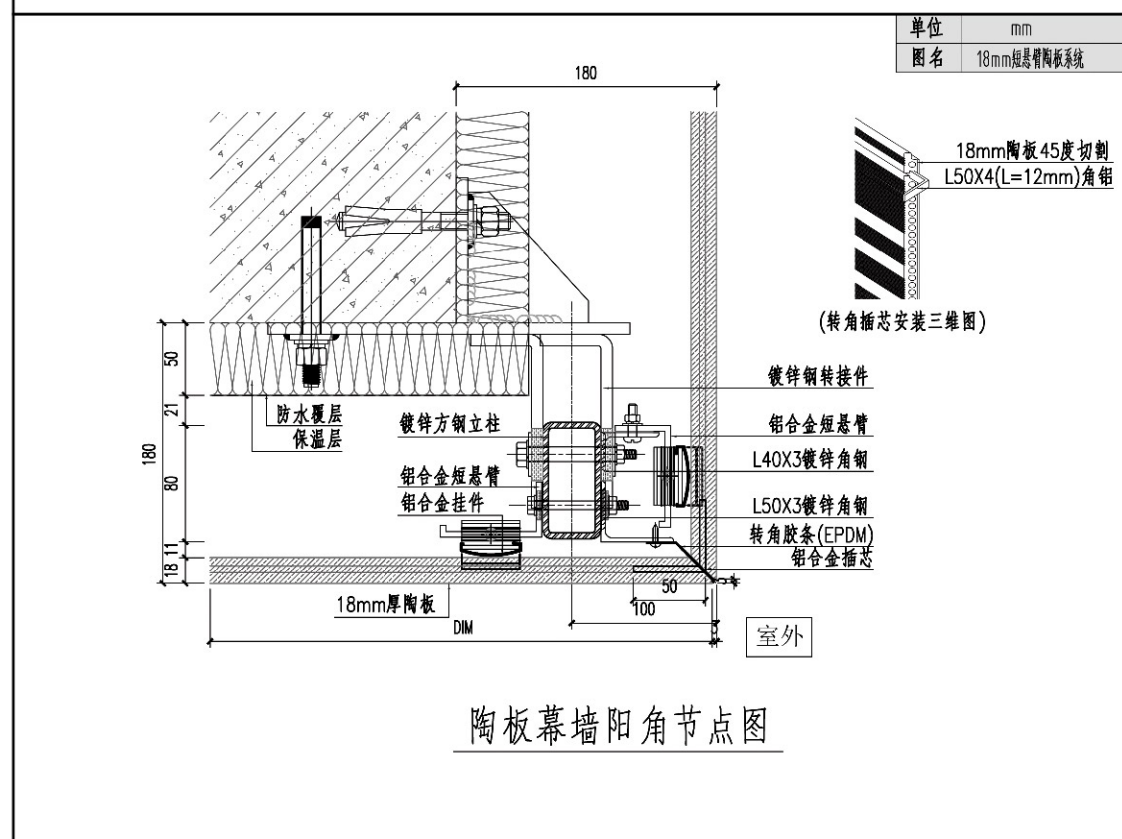
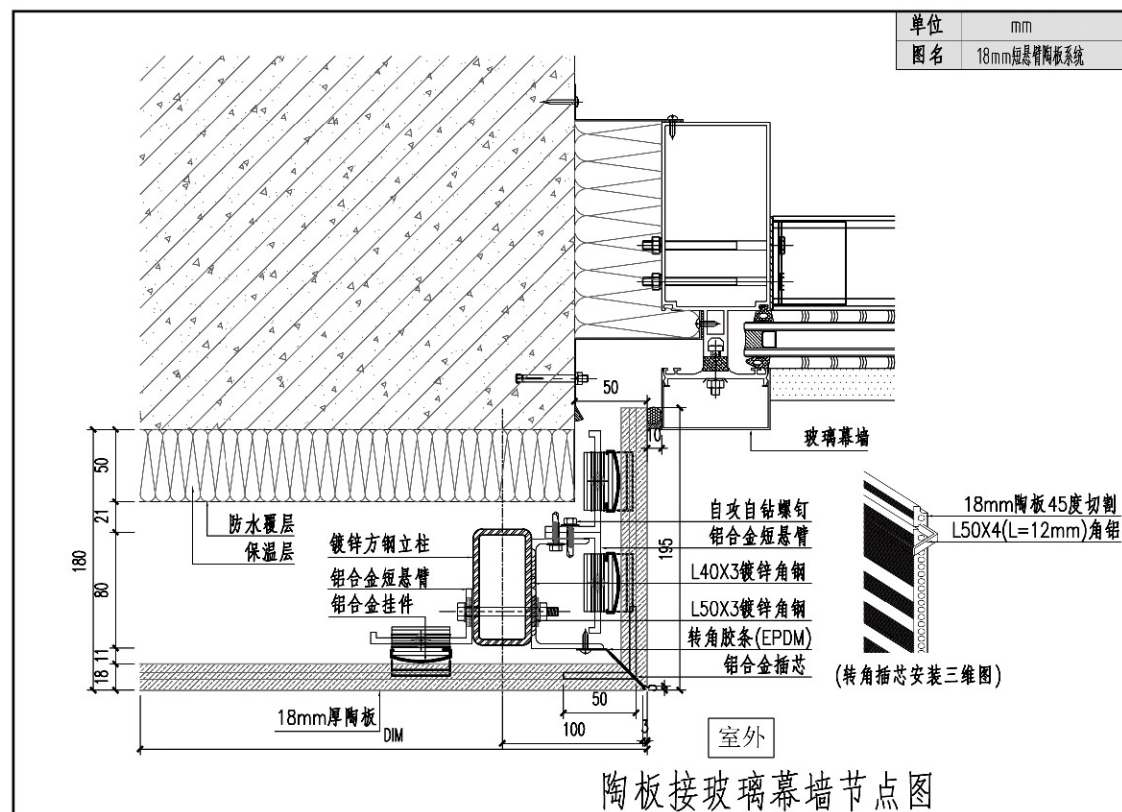

1.
18mm
短悬臂陶板系
统安装节点图

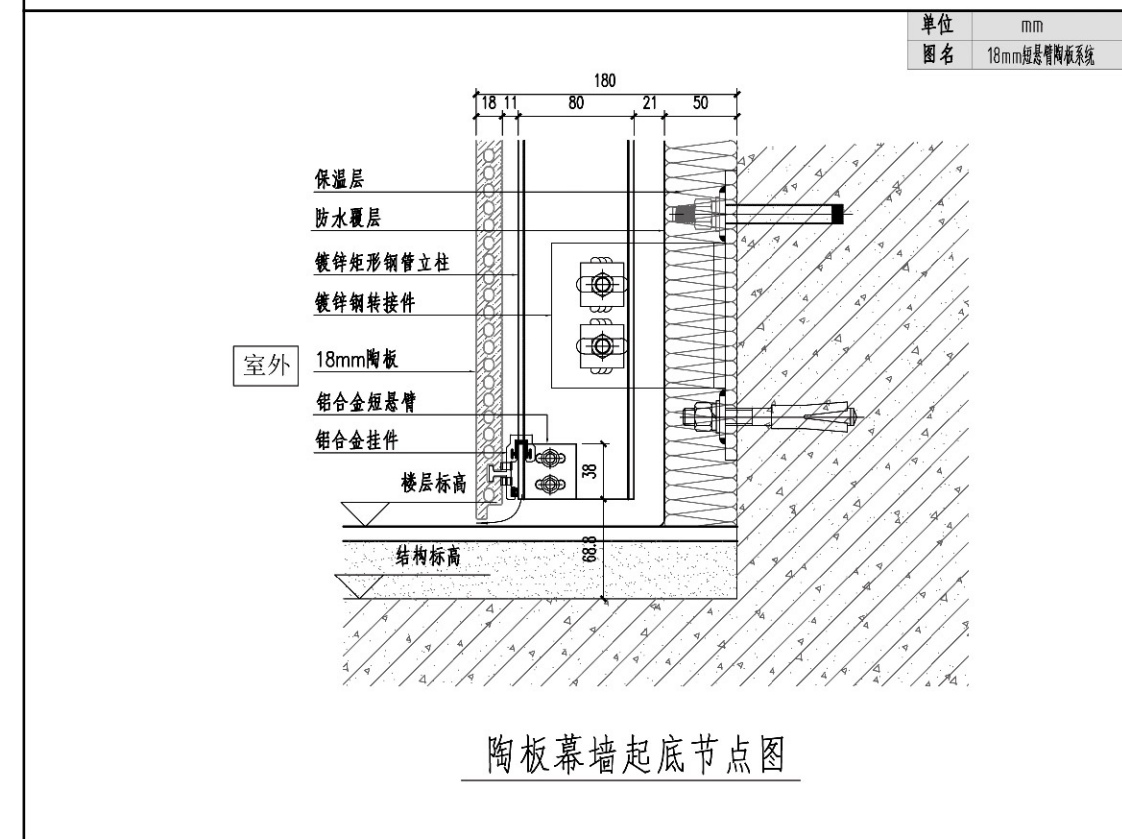
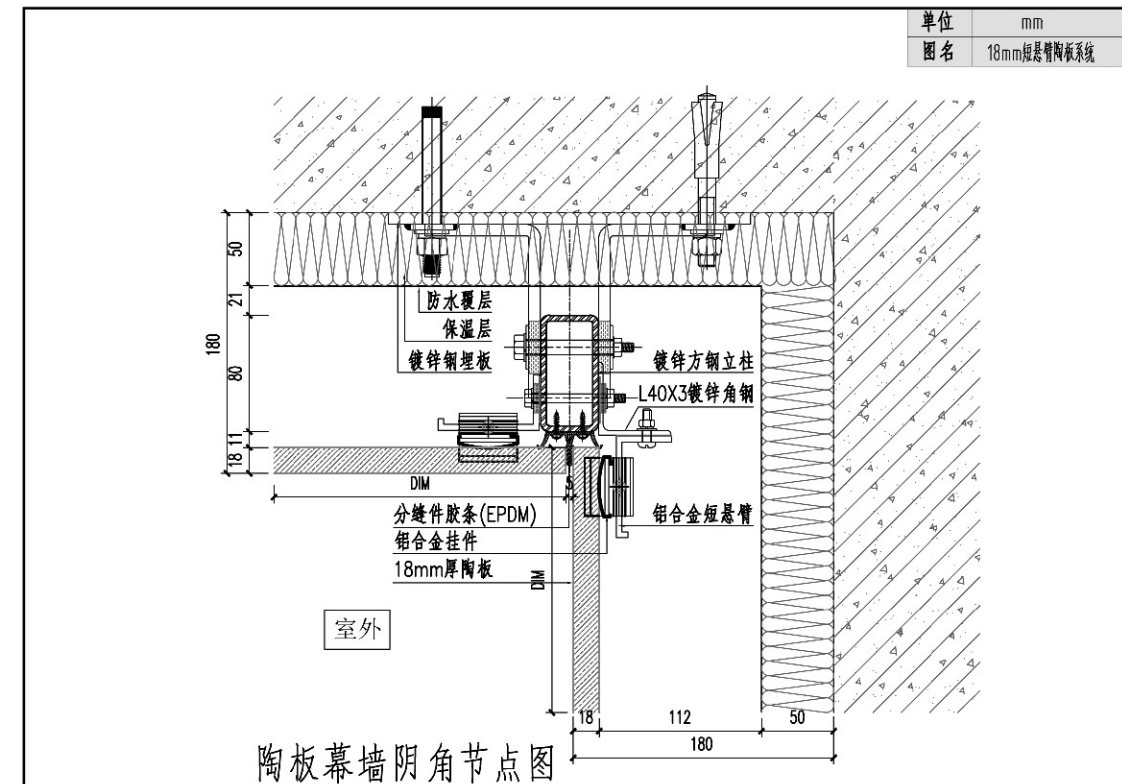

1.
18mm
短悬臂陶板系
统安装节点图

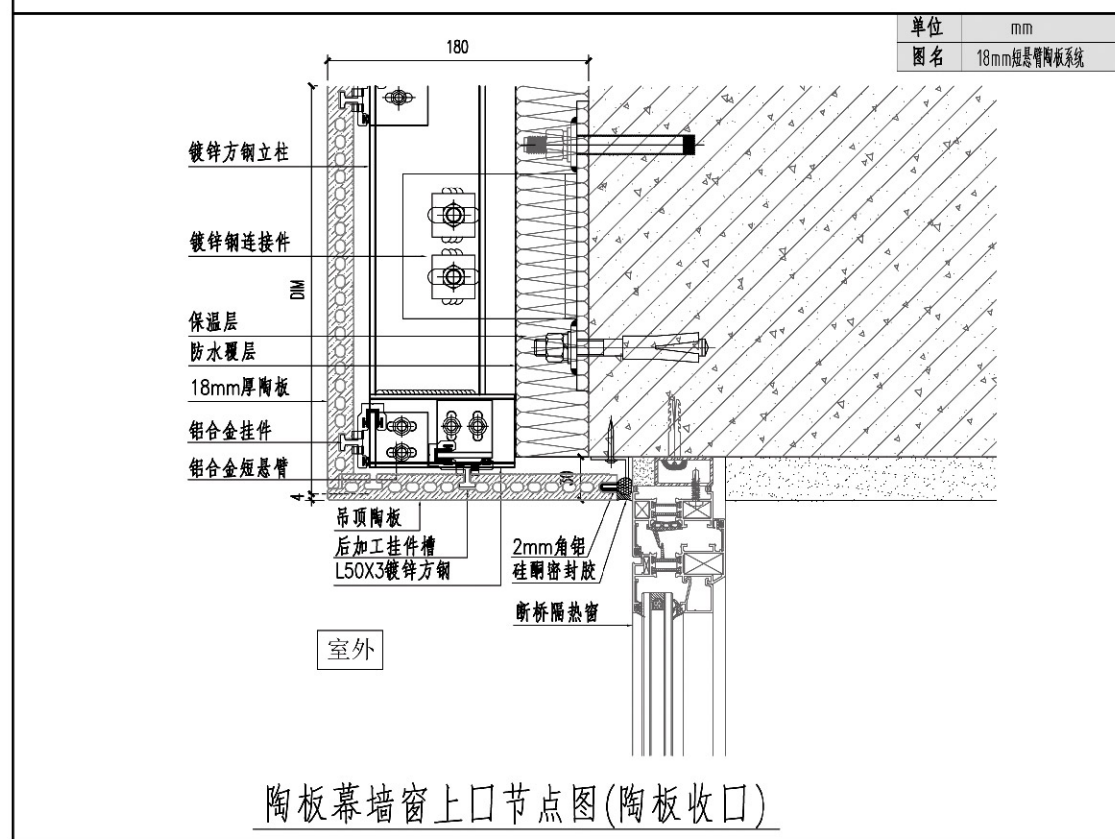
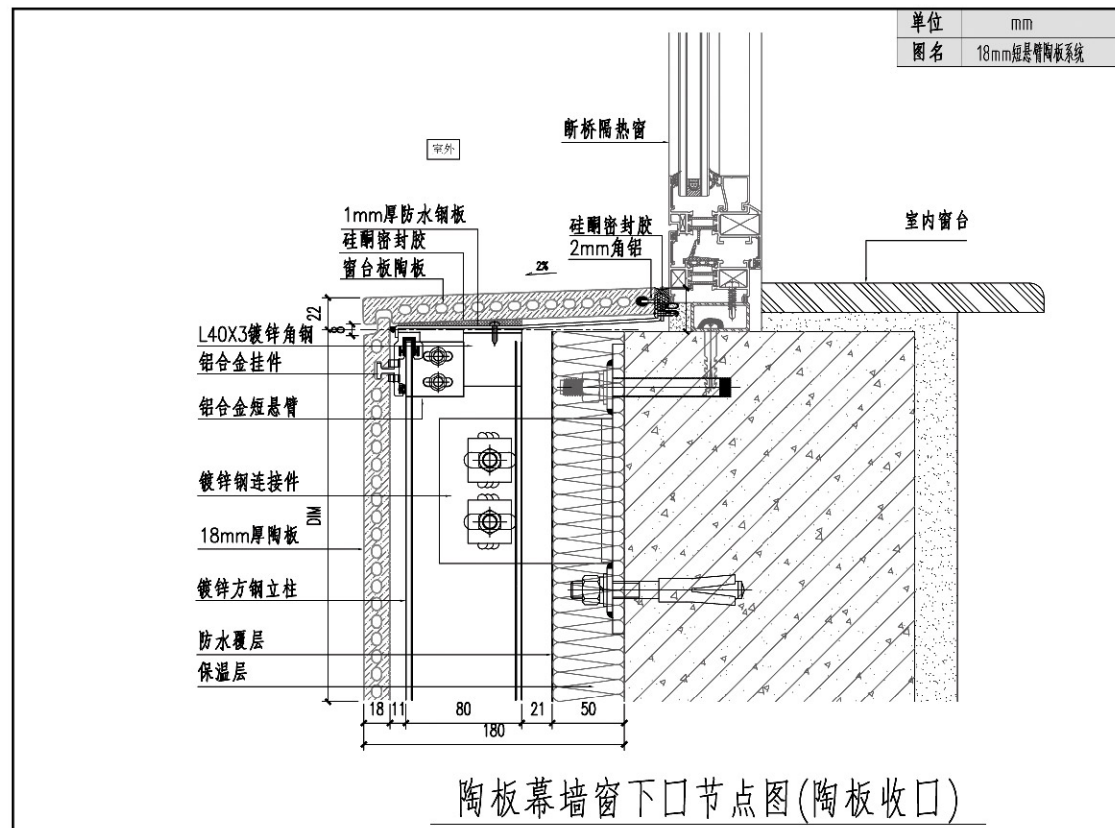

1.
18mm
短悬臂陶板系
统安装节点图

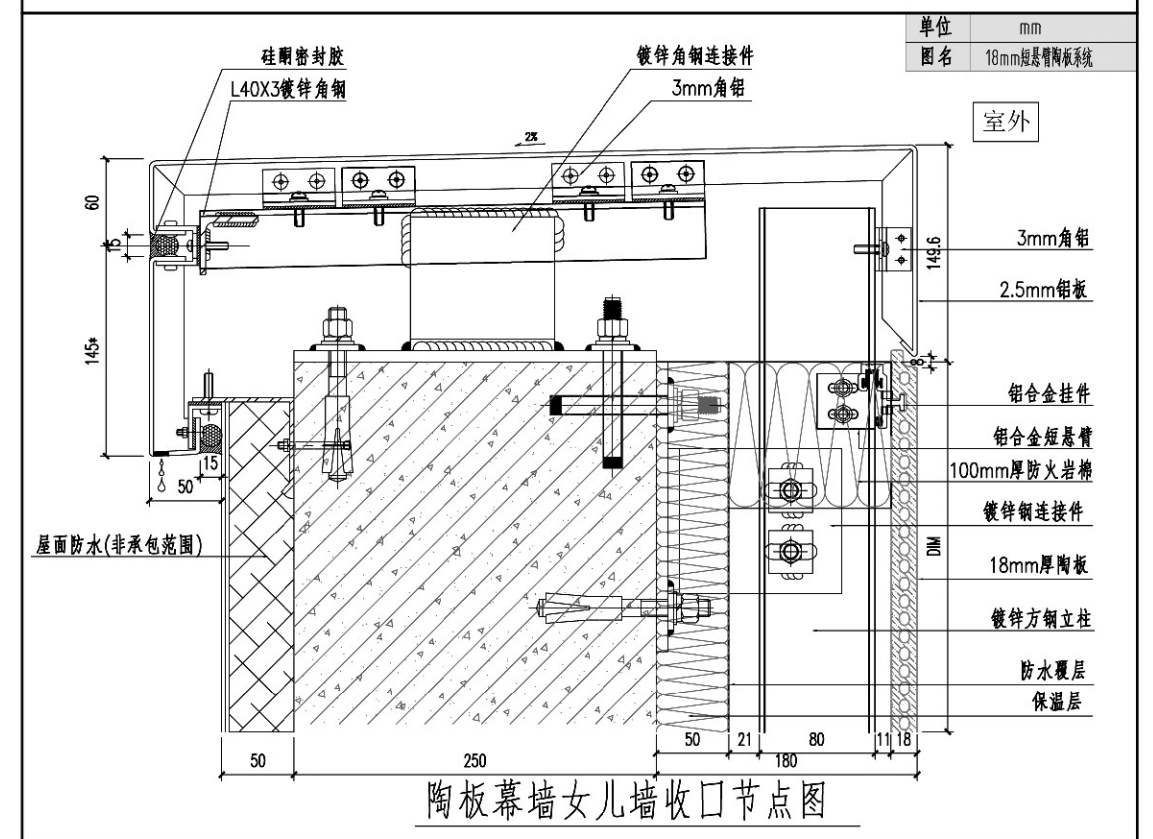
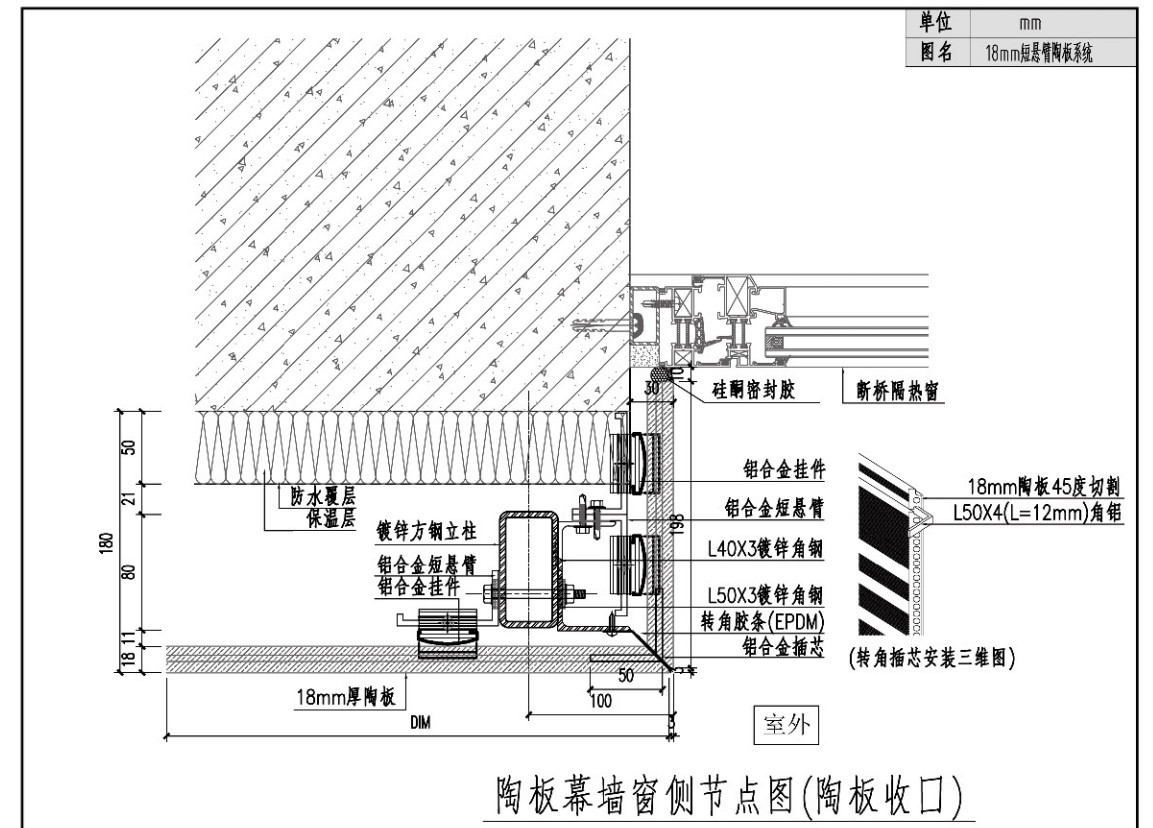

1.
18mm
短悬臂陶板系
统安装节点图

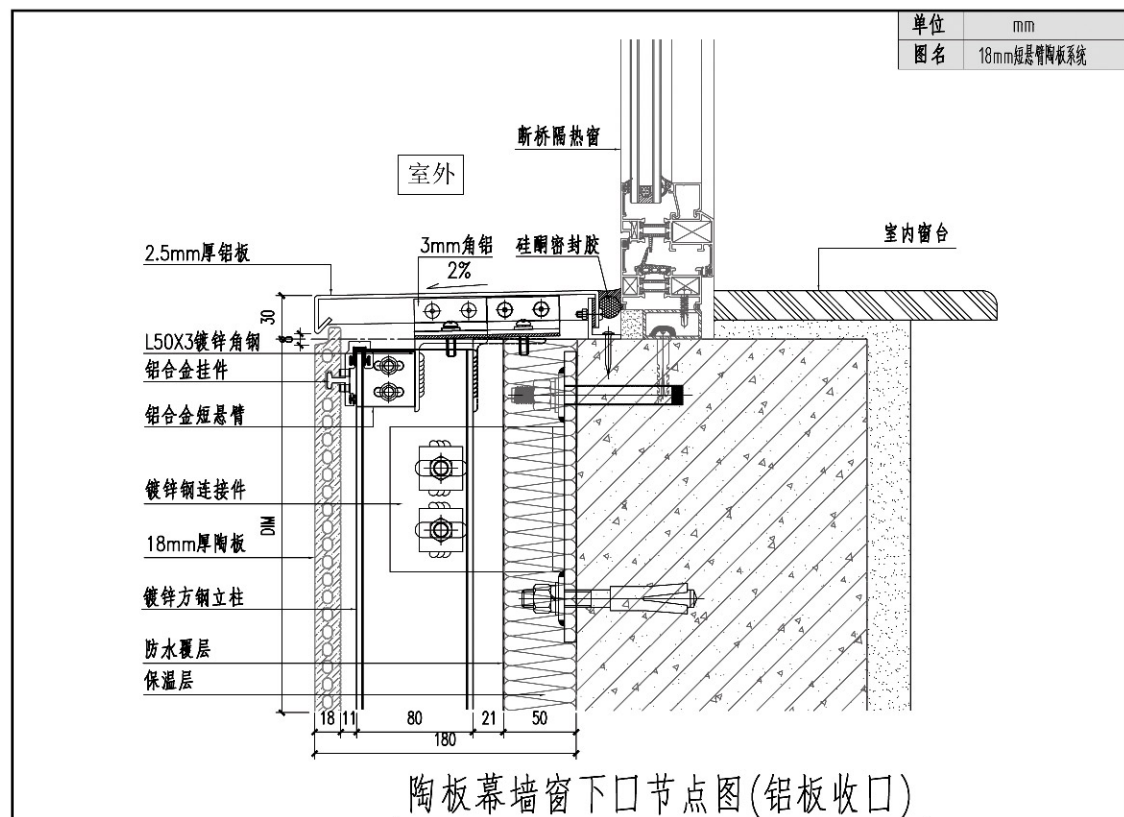

1.
18mm
短悬臂陶板系
统安装节点图

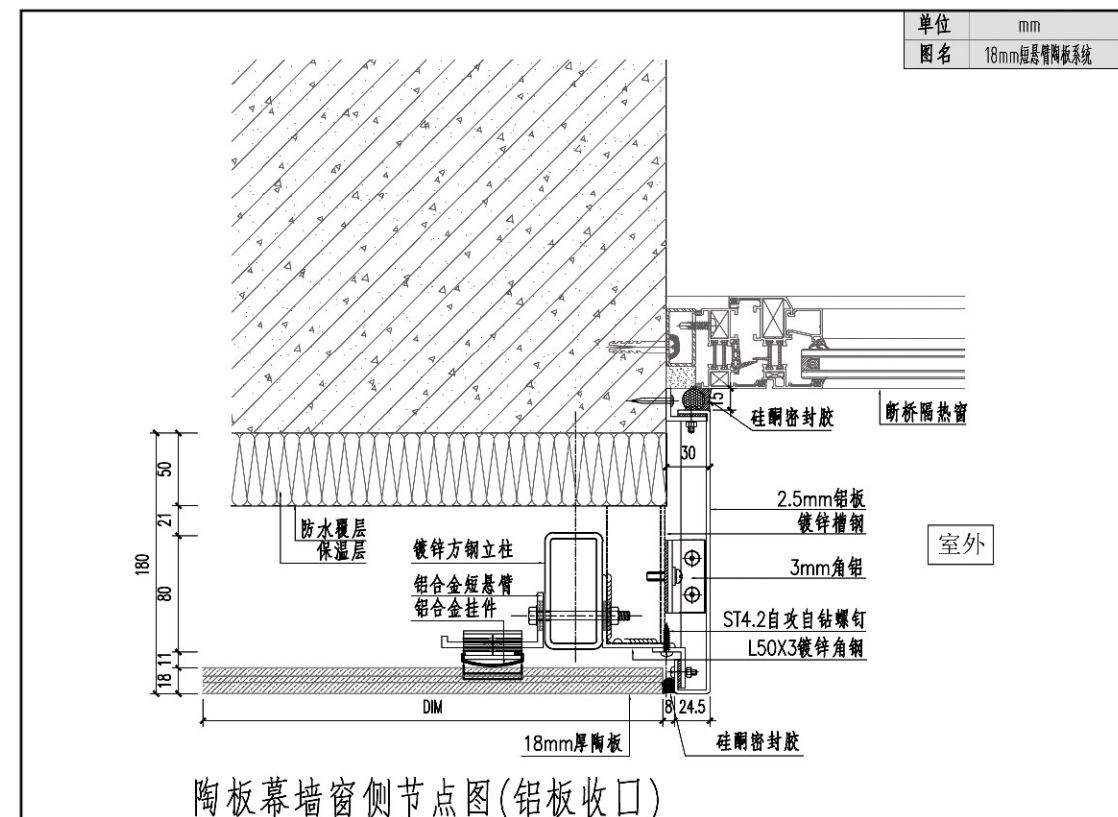

单位 mm
图名 18mm短悬臂陶板系统

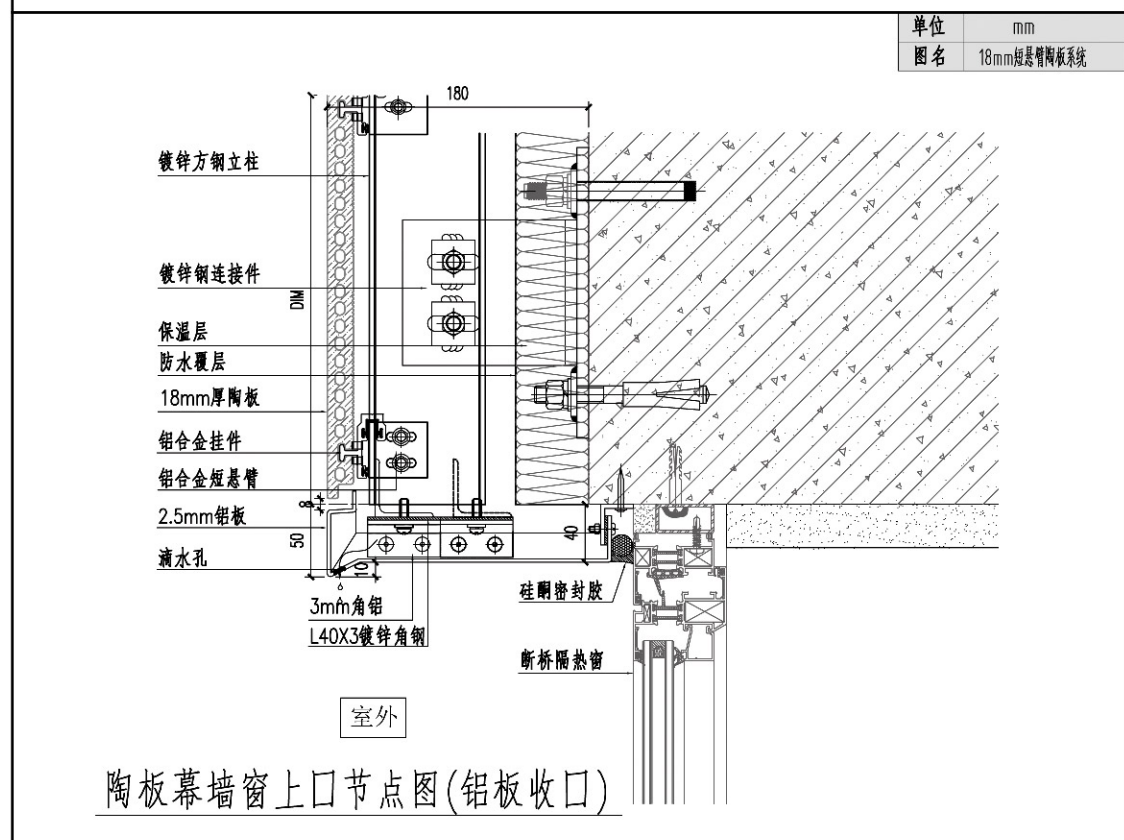

单位 mm
图名 18mm短悬臂陶板系统

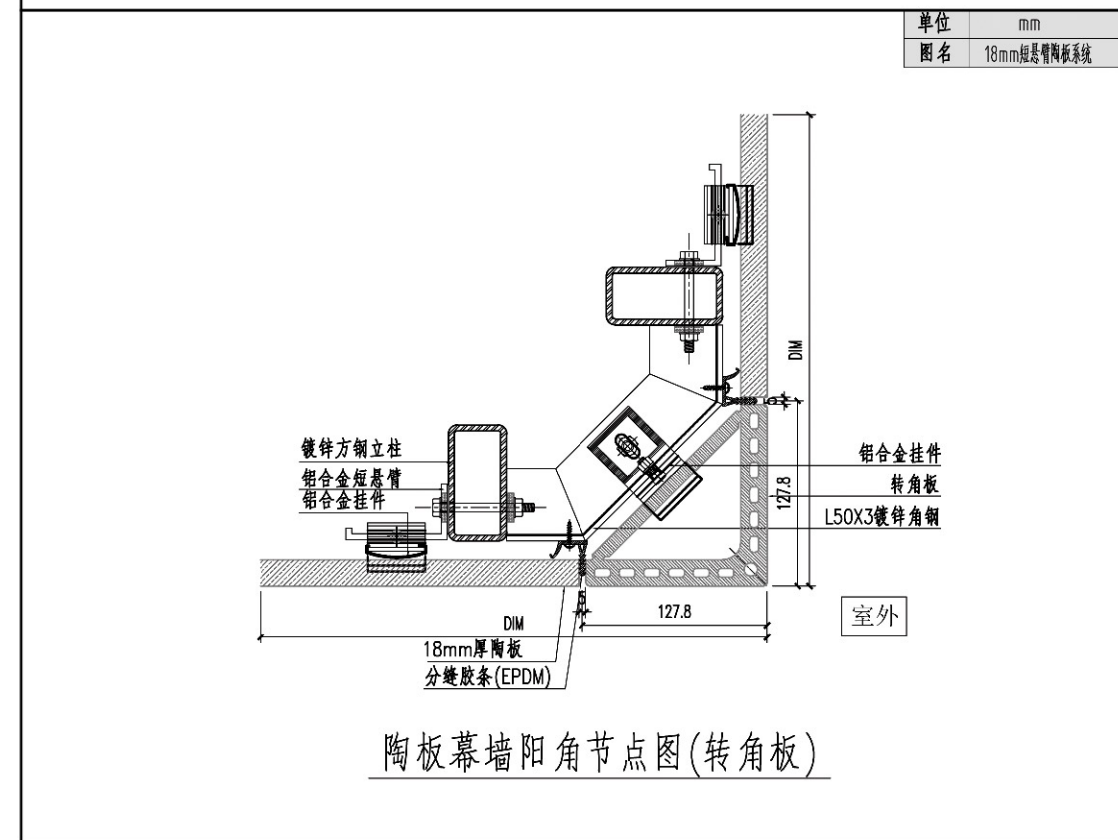

1.

18mm
短悬臂陶板系
统安装节点图

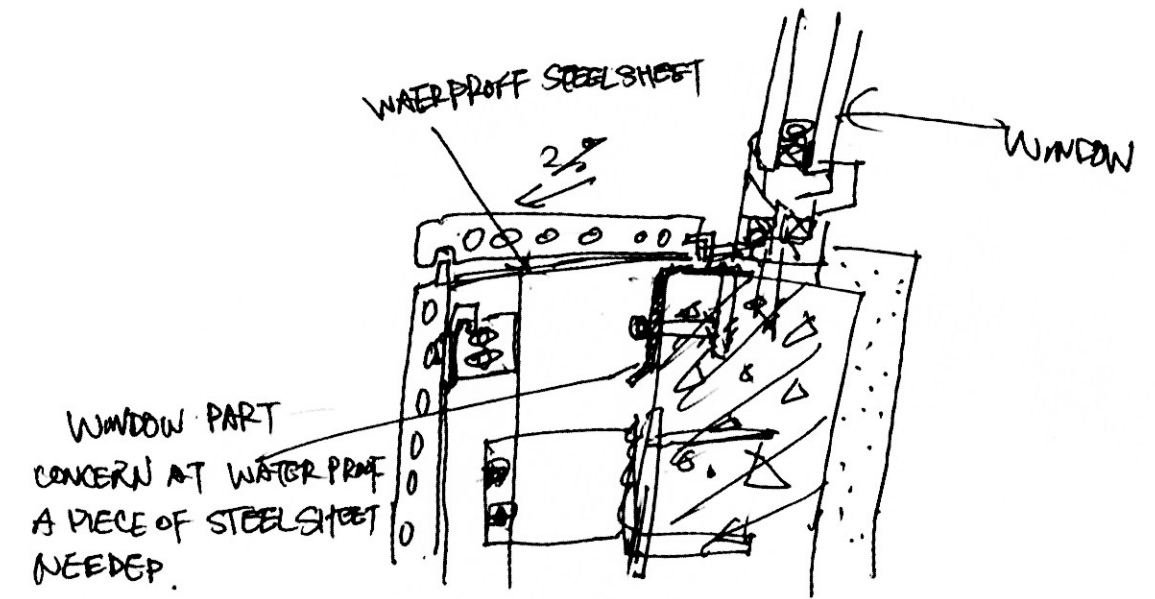
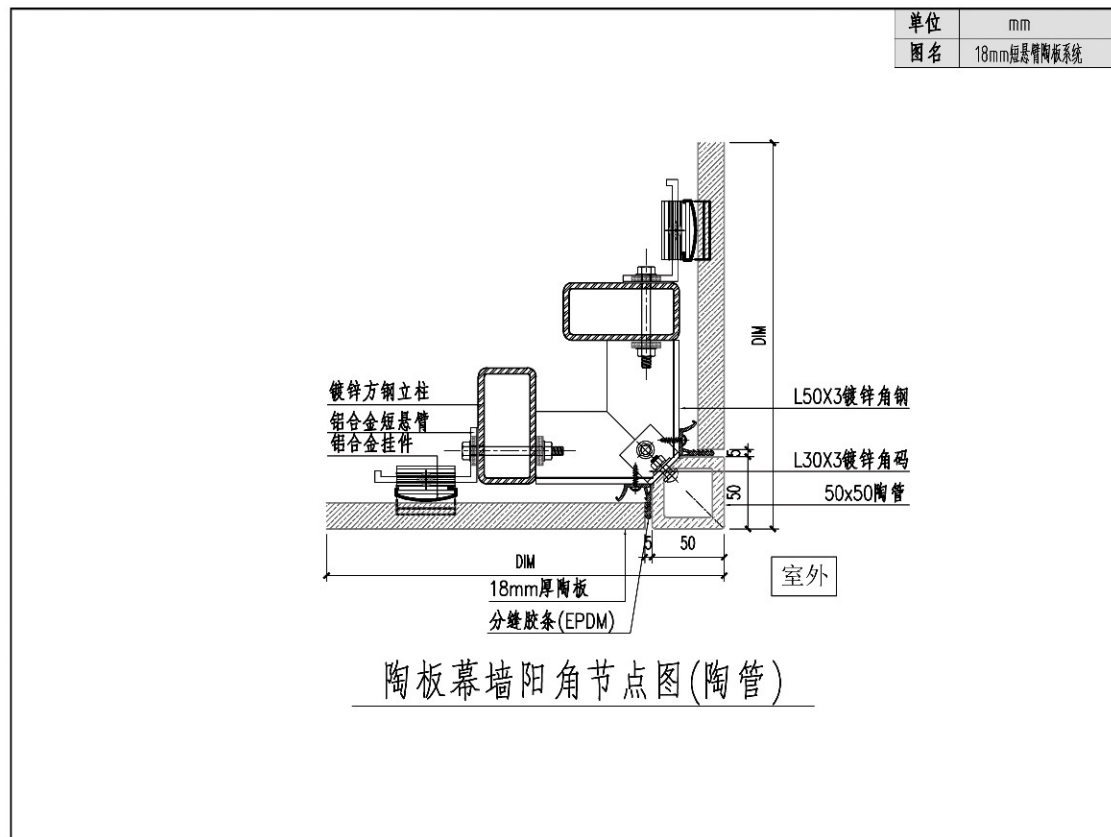

2.

18mm
短横梁陶板系
统安装节点图

2.

18mm
短横梁陶板系统(1)
安装节点图

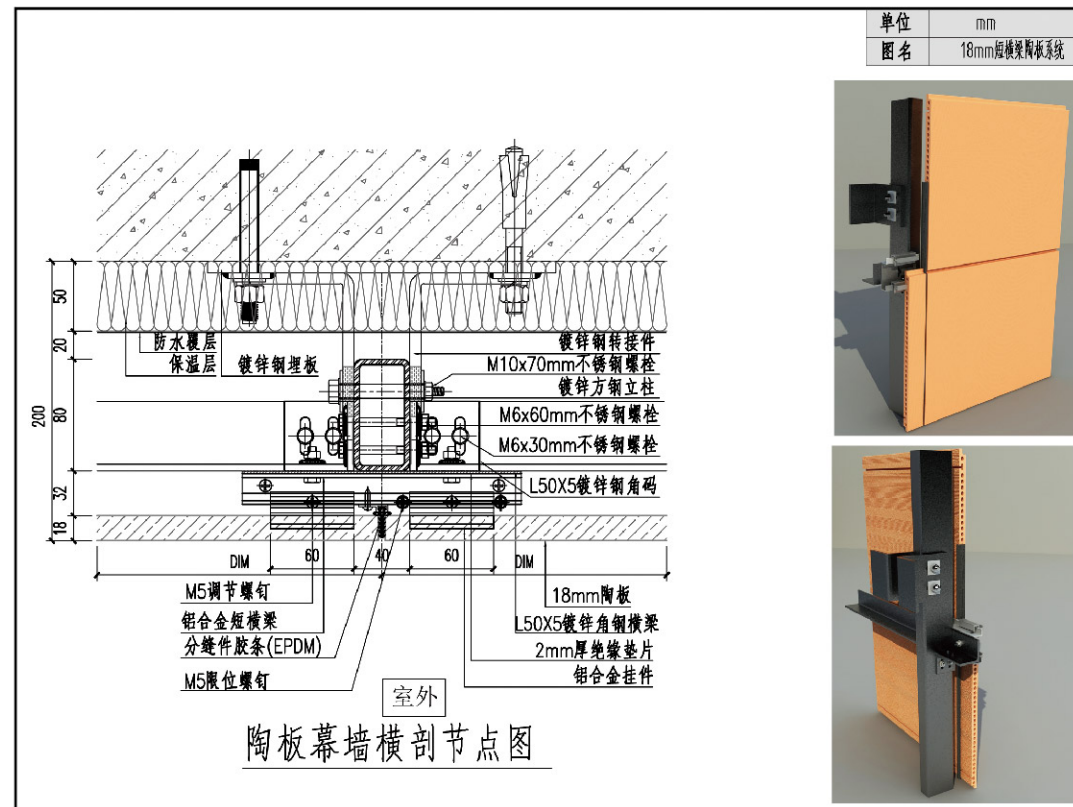

2.

18mm
短横梁陶板系统(1)
安装节点图

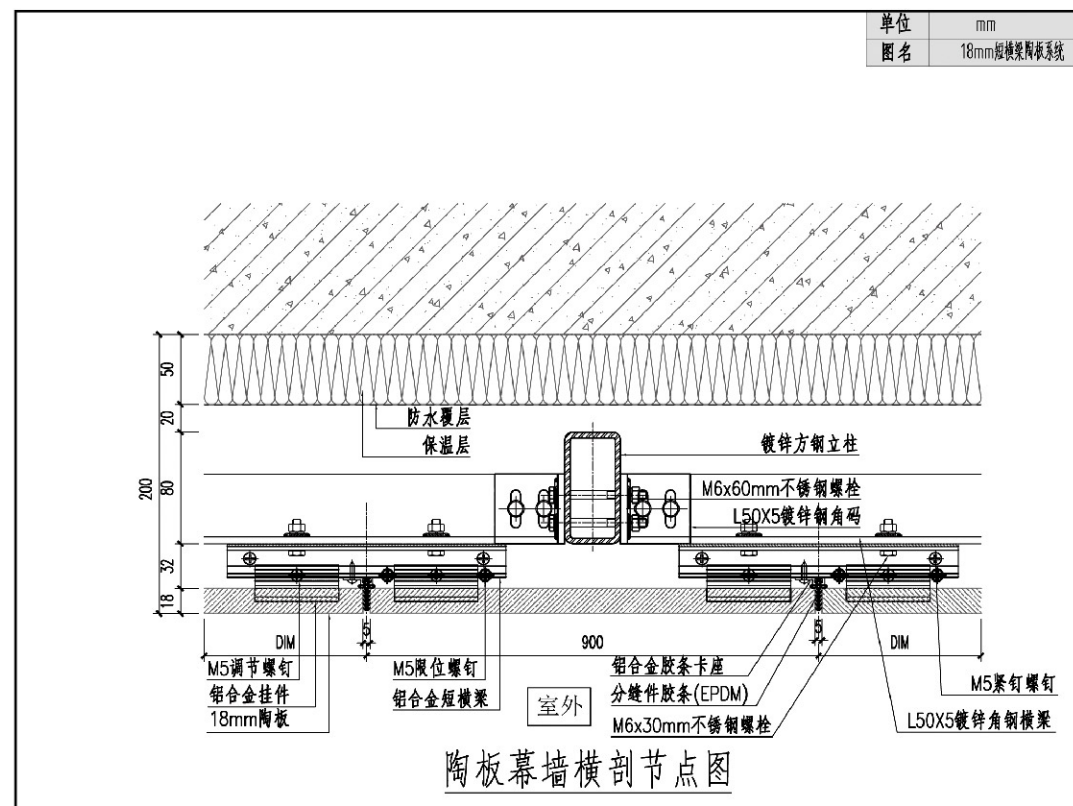
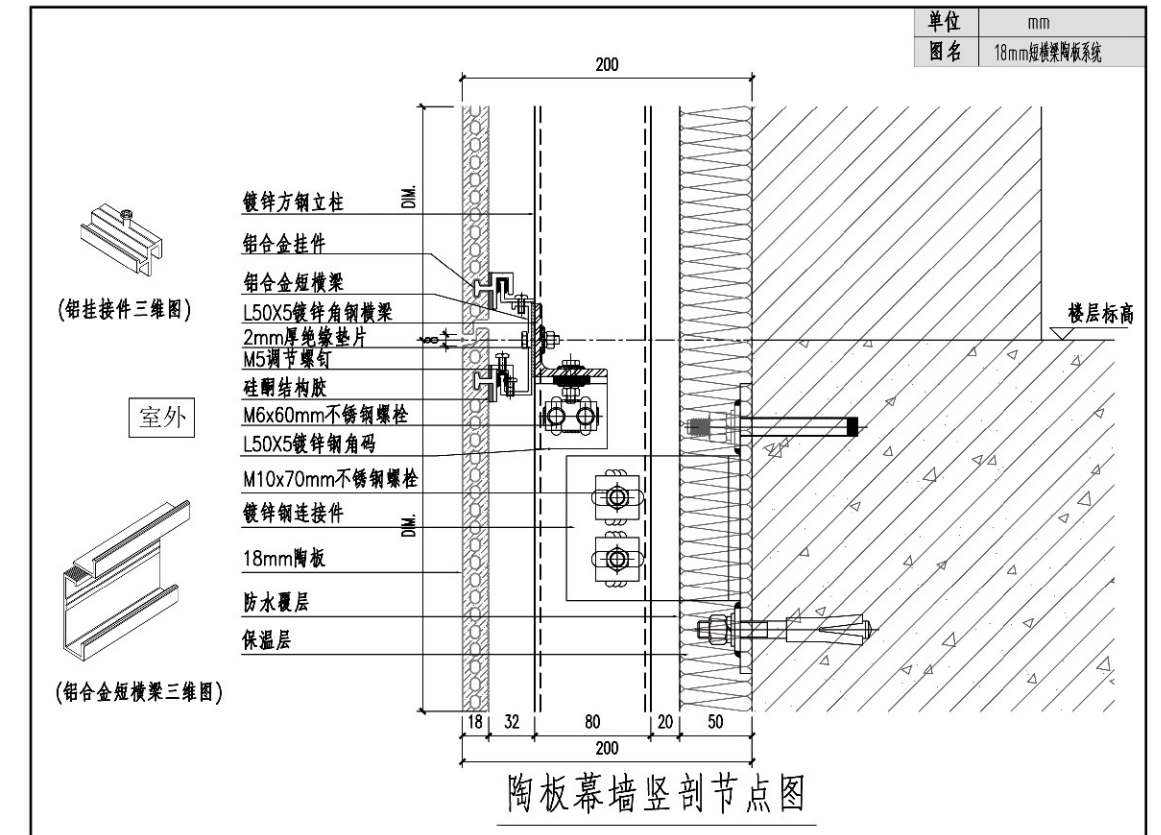

2.

18mm
短横梁陶板系统(2)
安装节点图

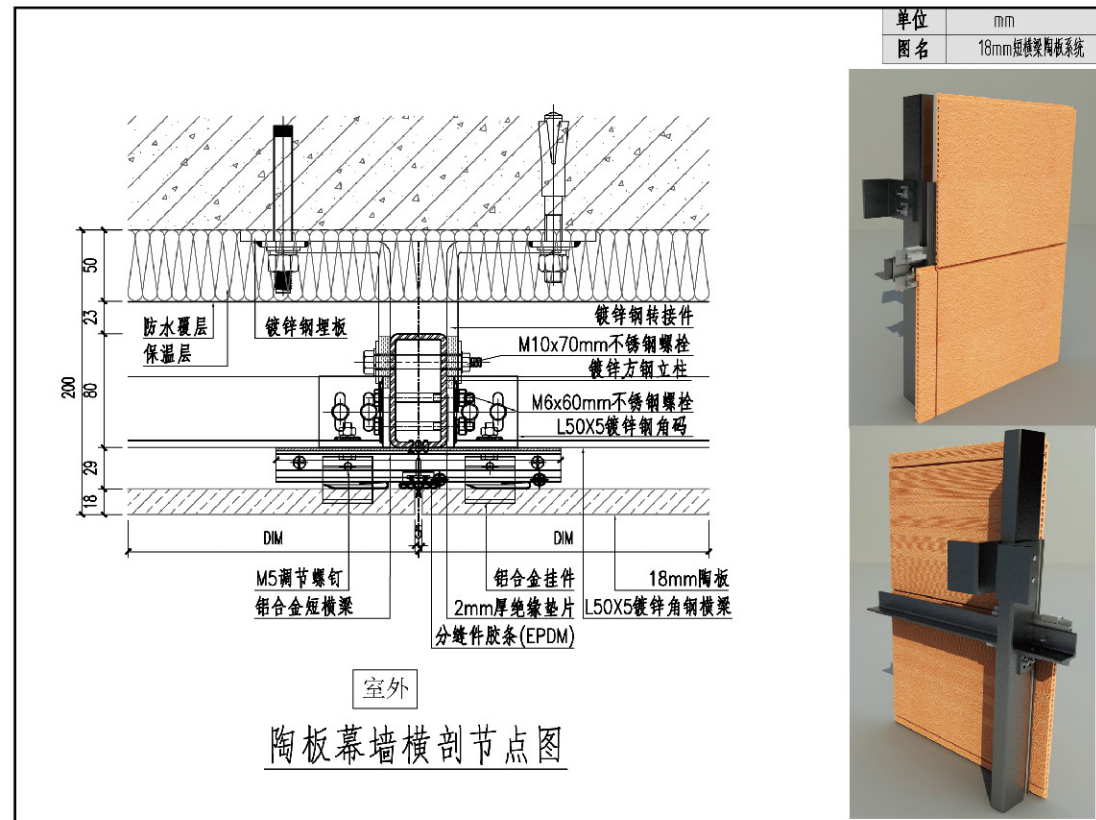

2.

18mm
短横梁陶板系统(2)
安装节点图

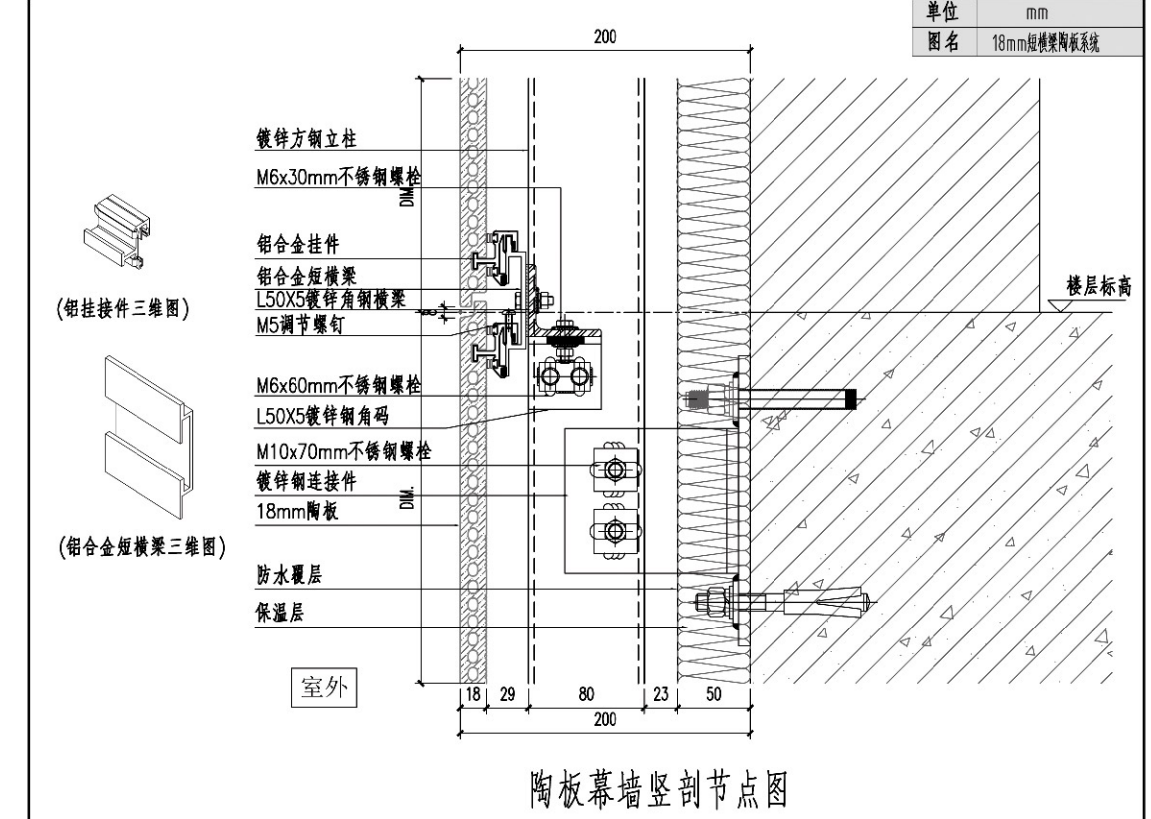
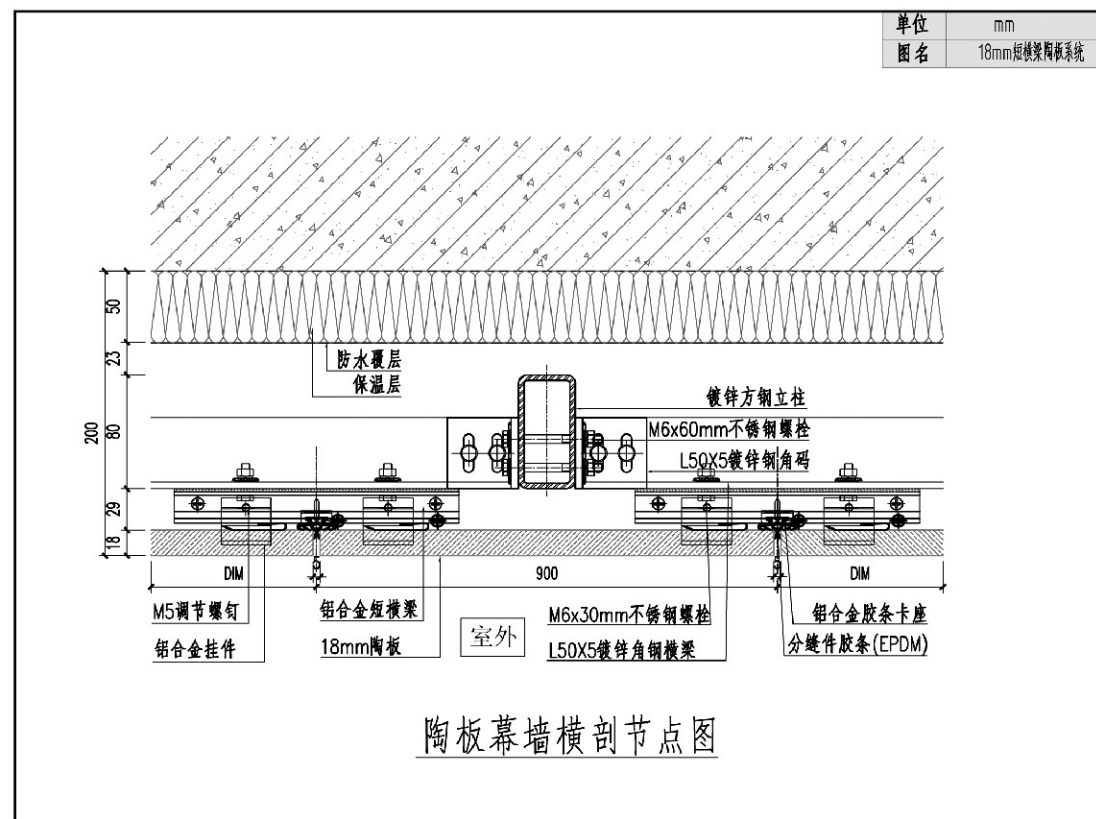
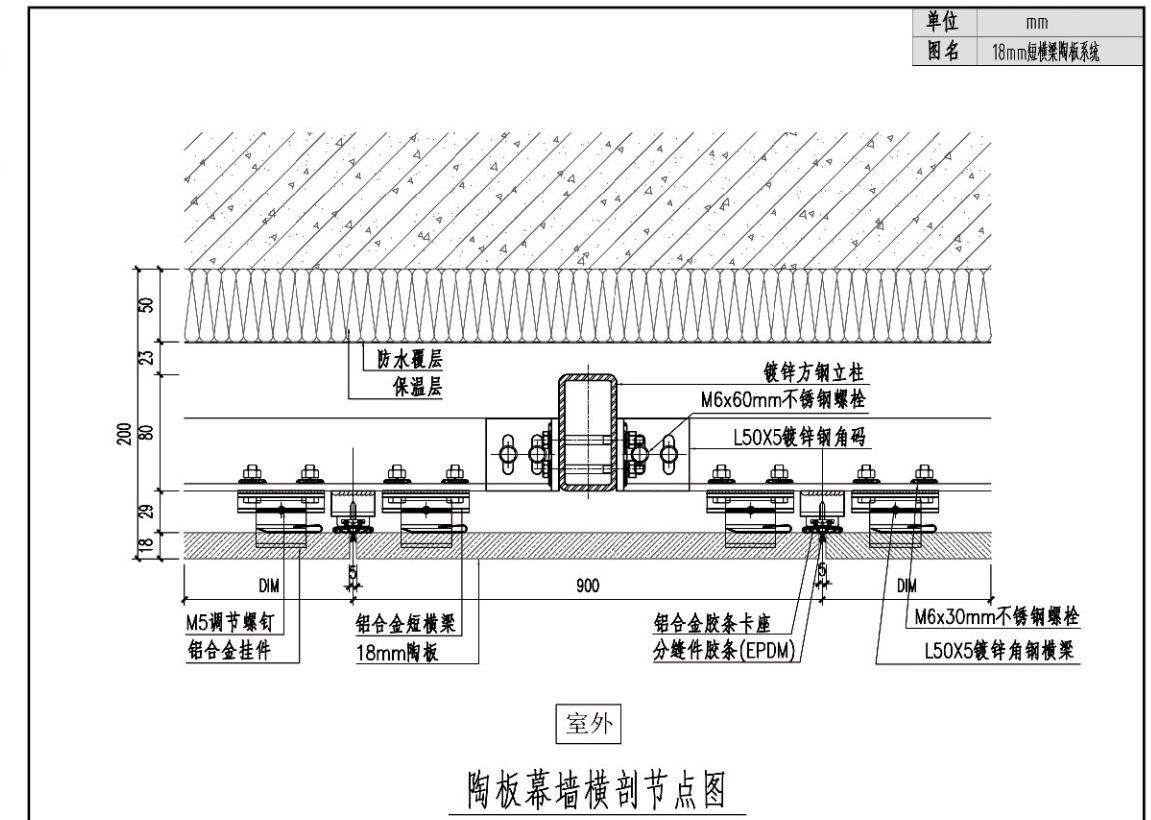

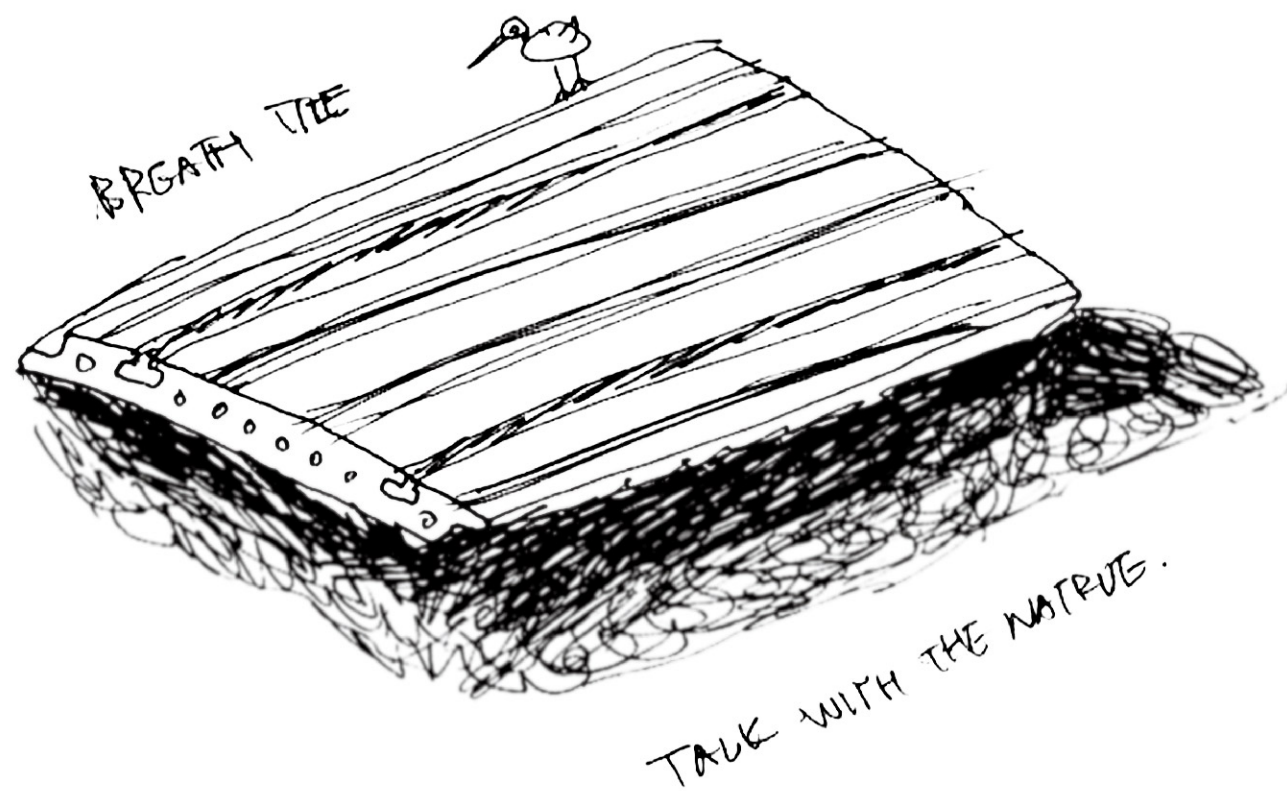

3.

18mm 横滑紧定式竖向 系统安装节点图

3.

18mm 横滑紧定式竖向系 统安装节点图

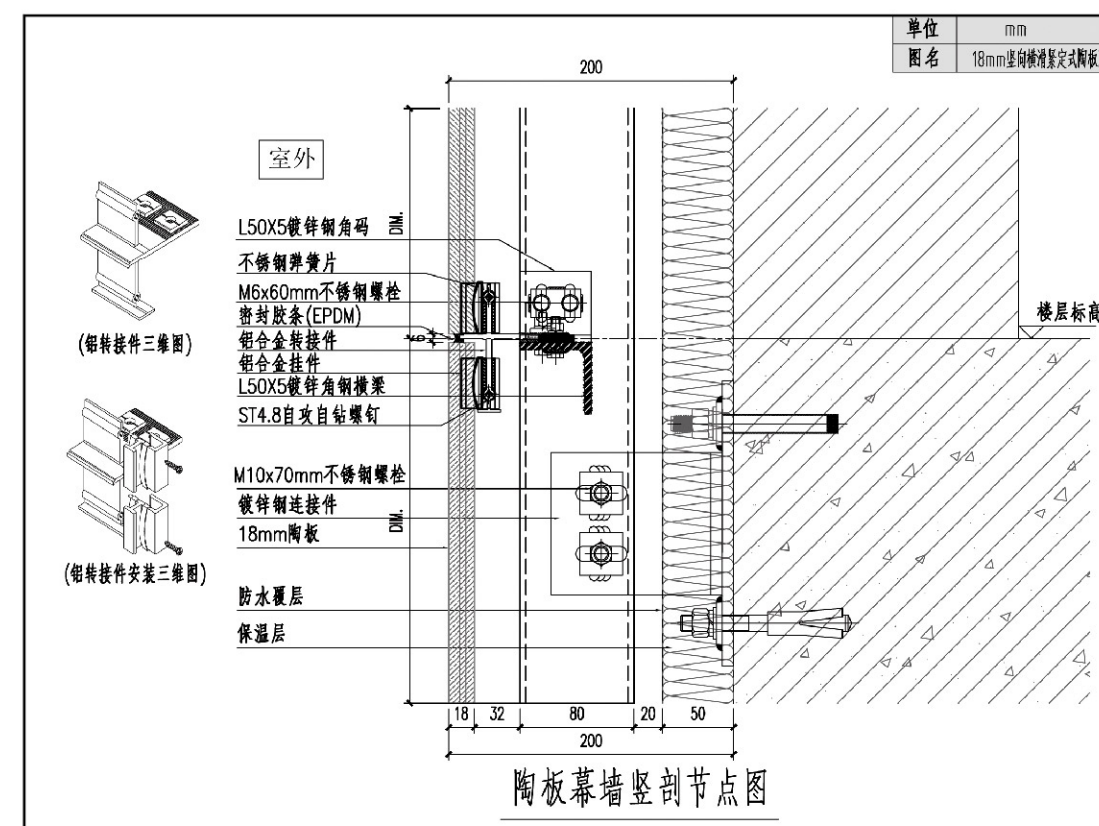
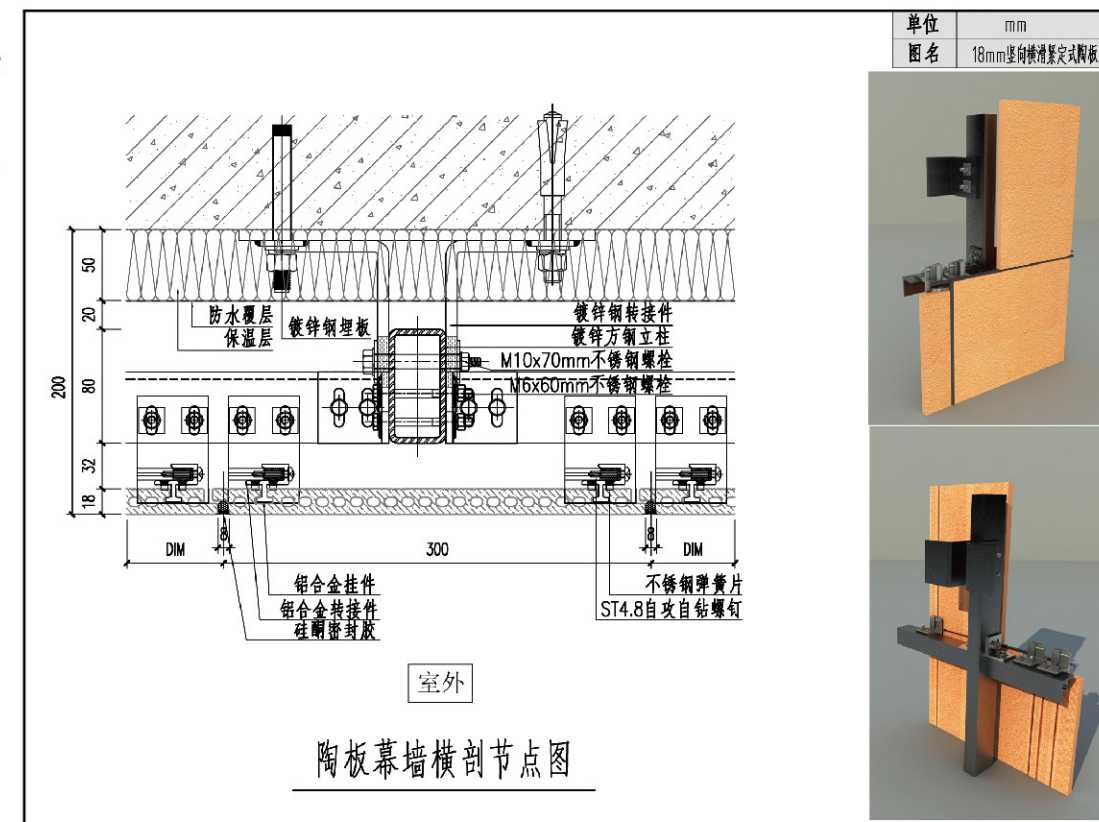

3.

18mm
横滑紧定式竖向系
统安装节点图

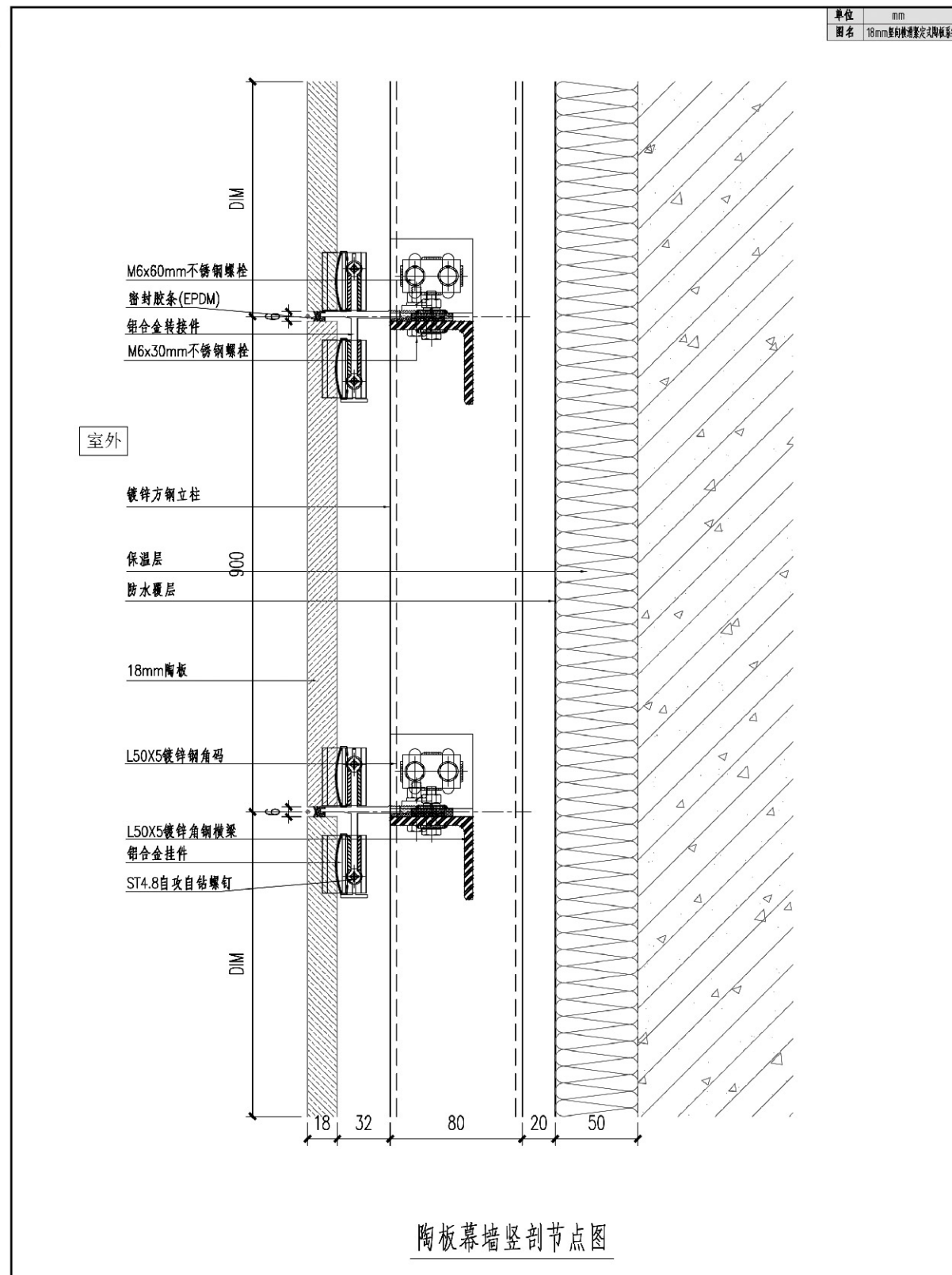

3.

18mm
横滑紧定式竖向系
统安装节点图

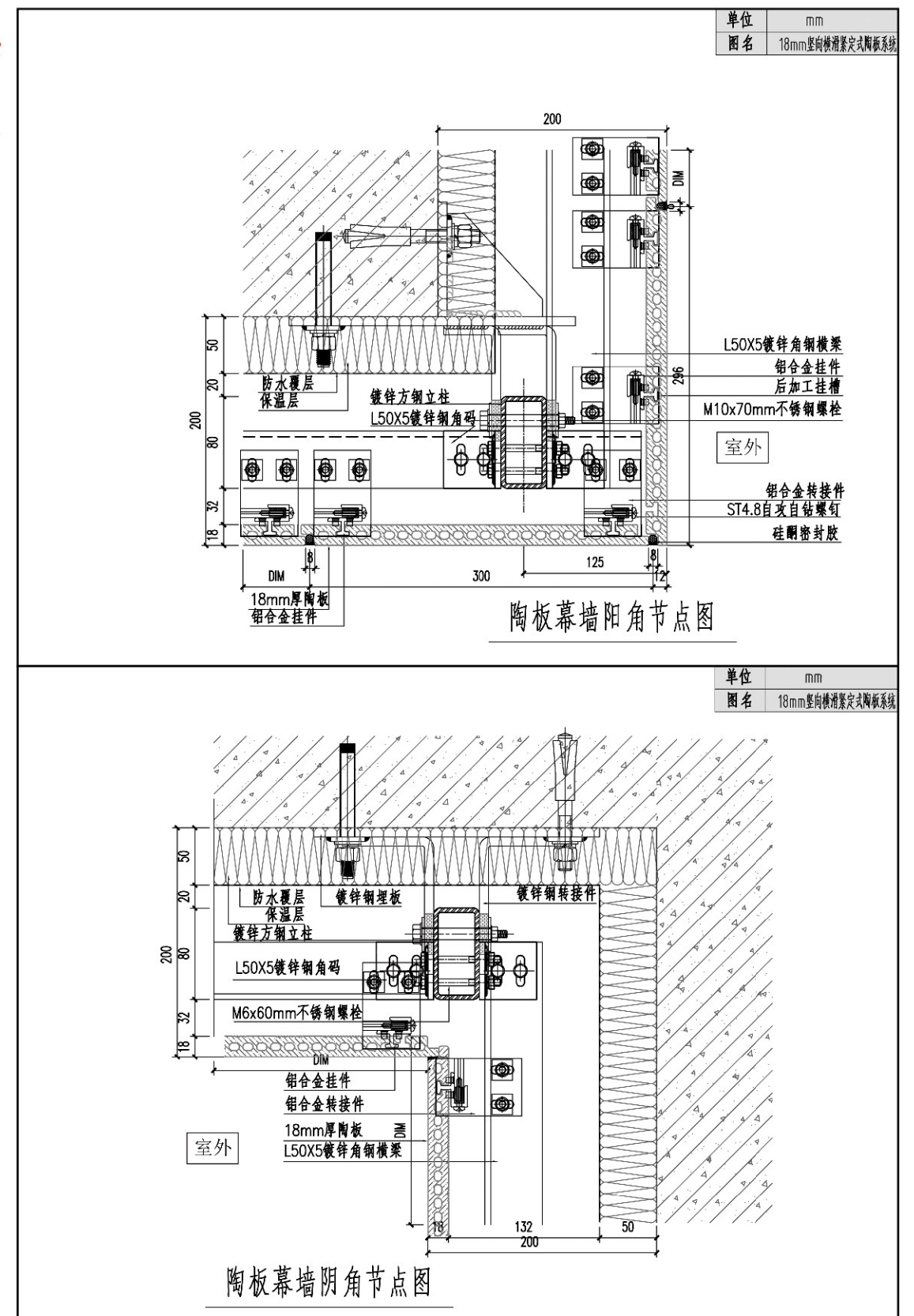

3.
18mm
横滑紧定式竖向系
统安装节点图

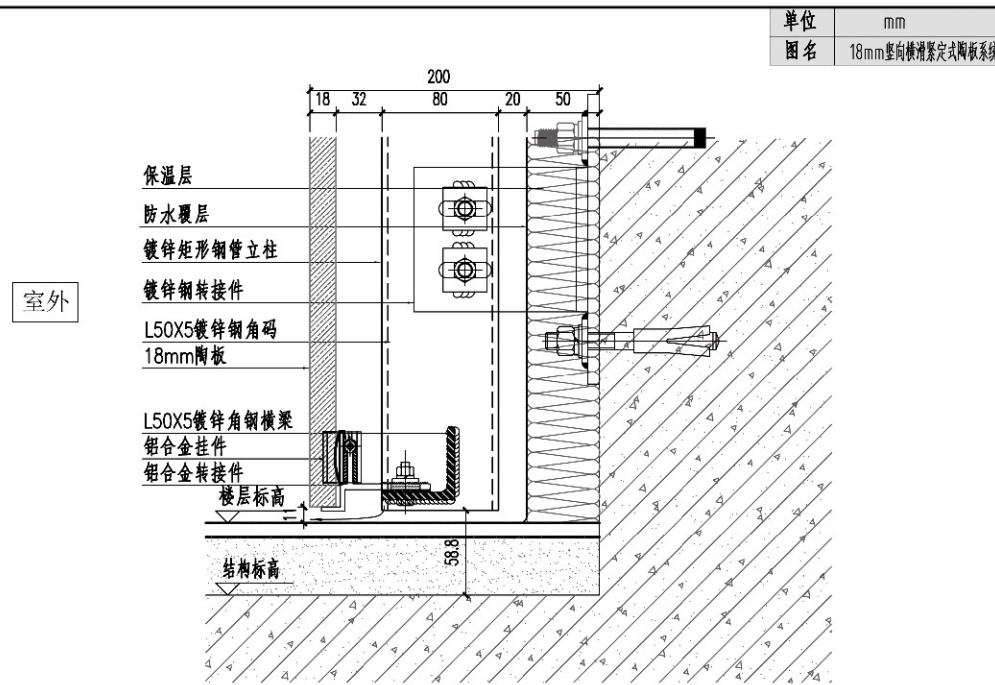

陶板幕墙起底节点图

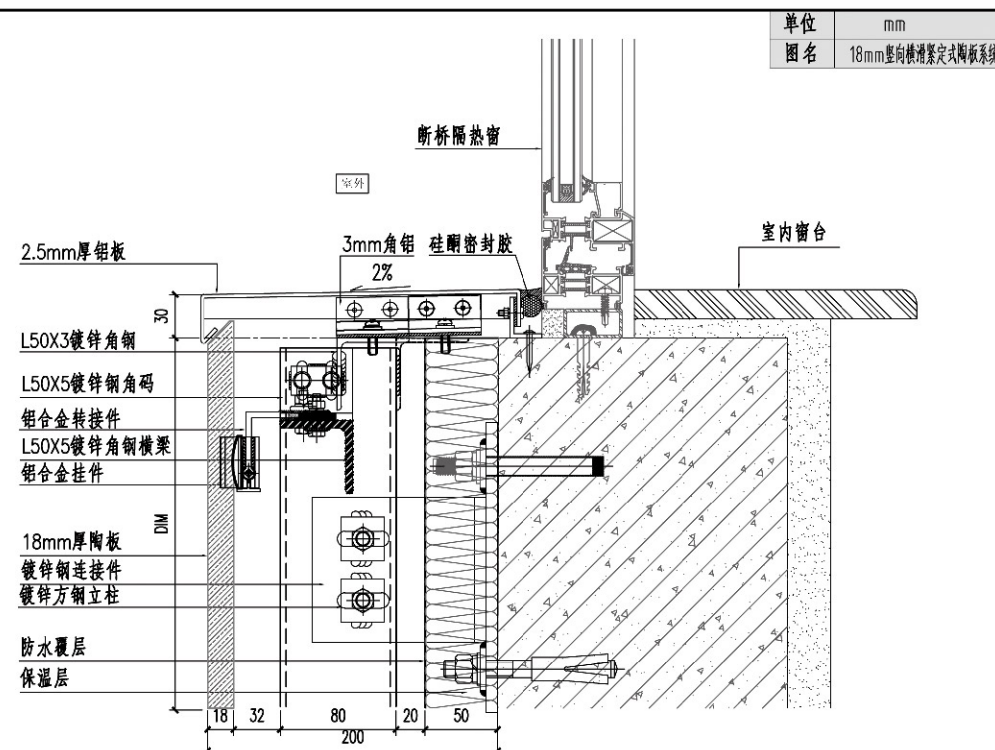

陶板幕墙窗下口节点图(铝板收口)

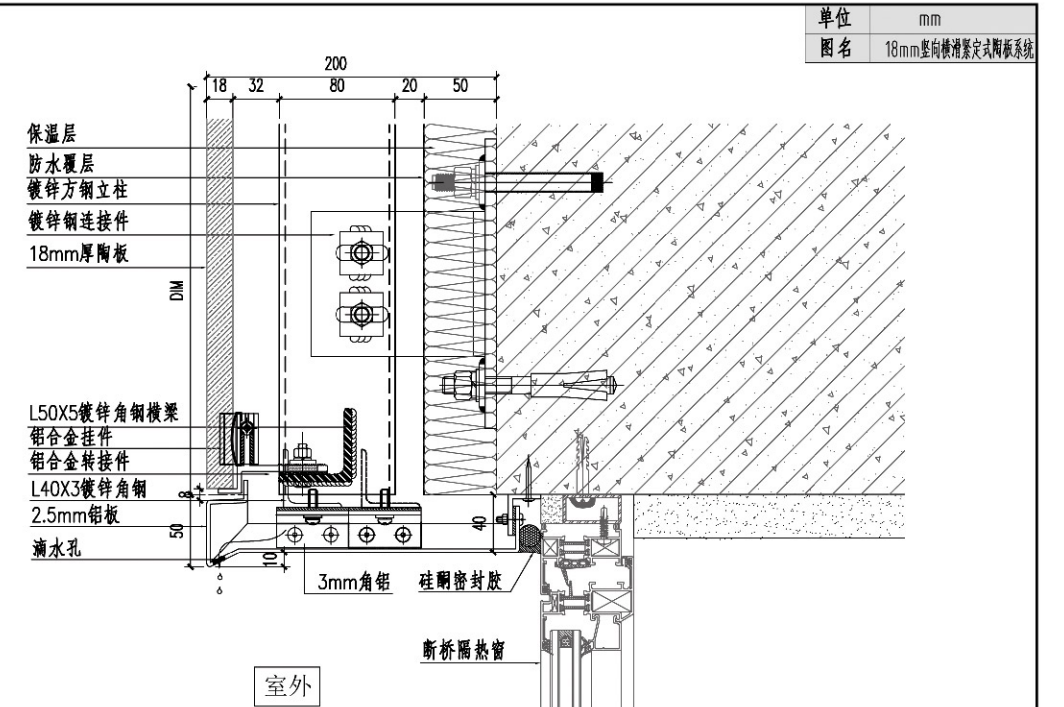

陶板幕墙窗上口节点图(铝板收口)

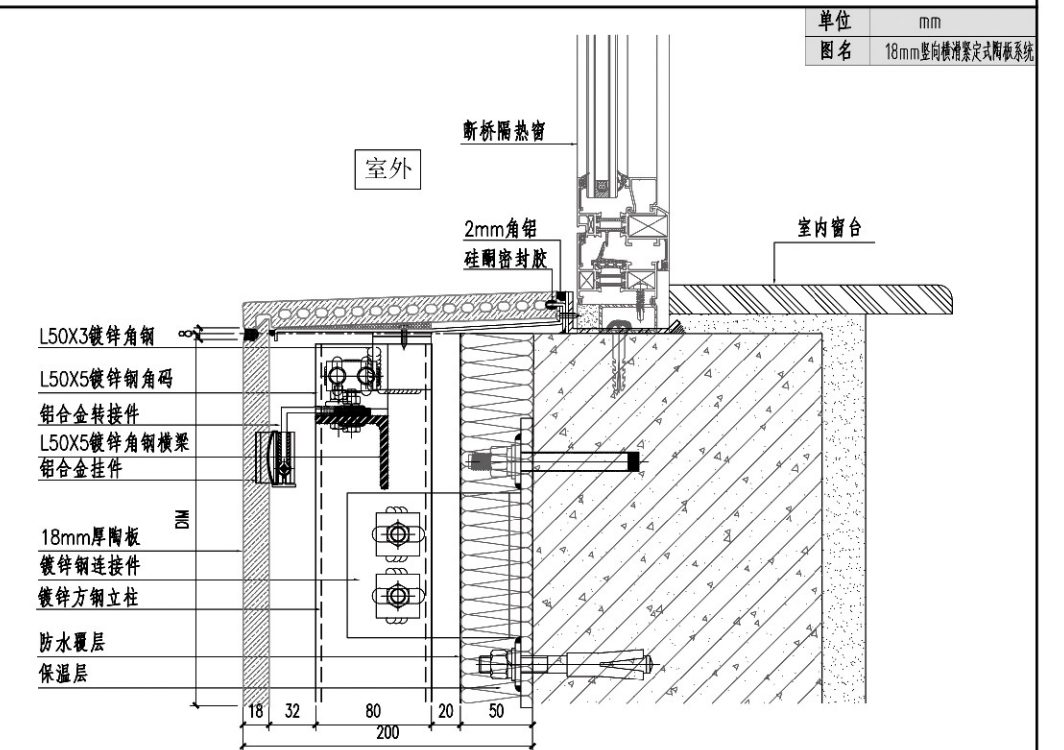

陶板幕墙窗下口节点图(陶板收口)

3.
18mm
横滑紧定式竖向系
统安装节点图

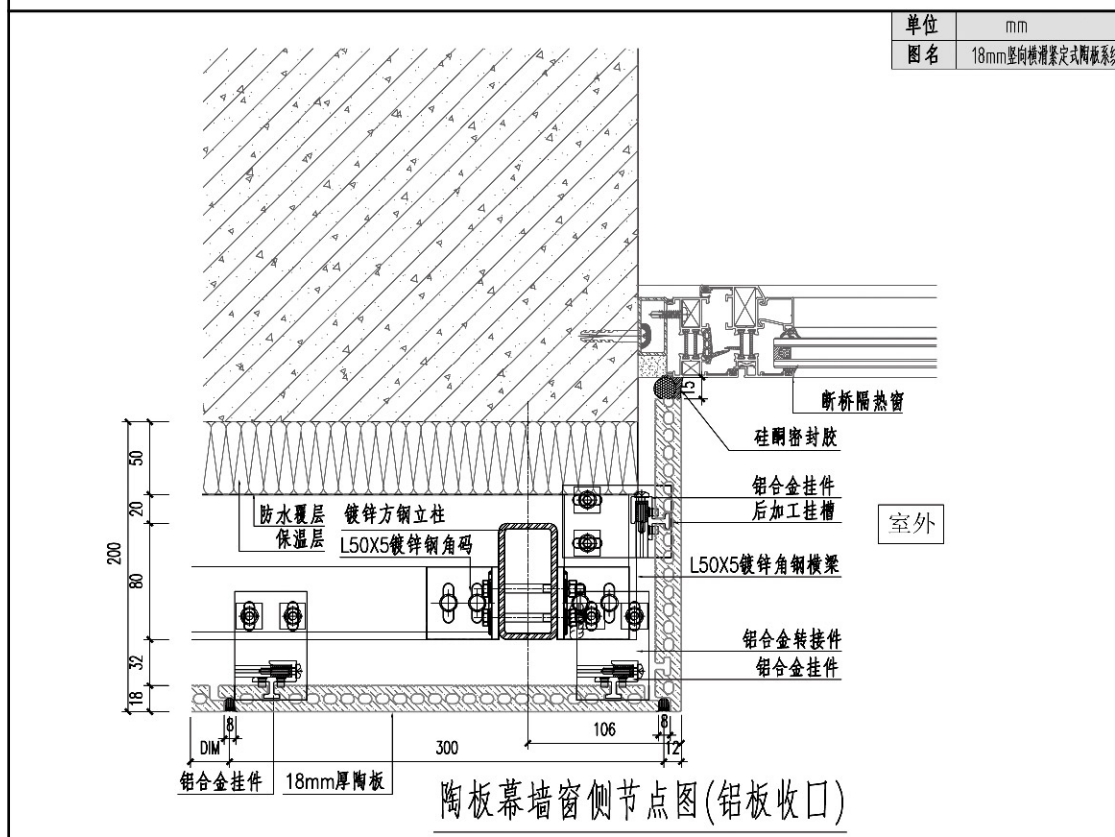
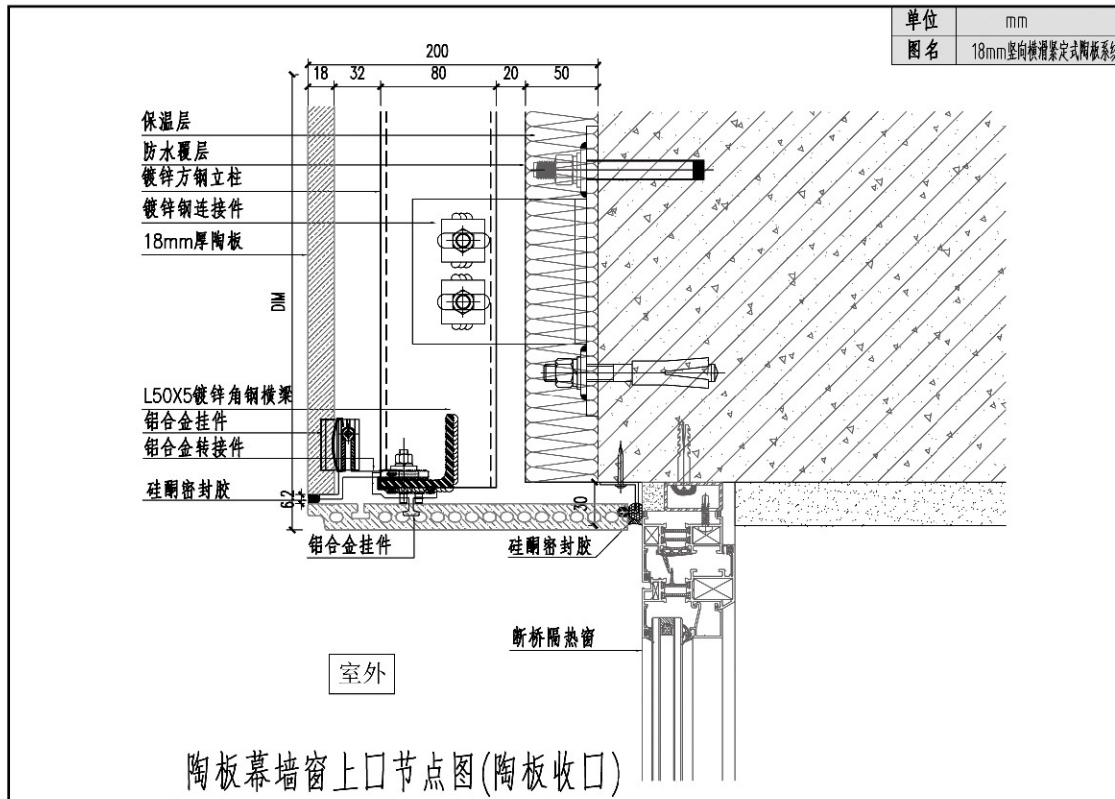

3.
18mm
横滑紧定式竖向系
统安装节点图

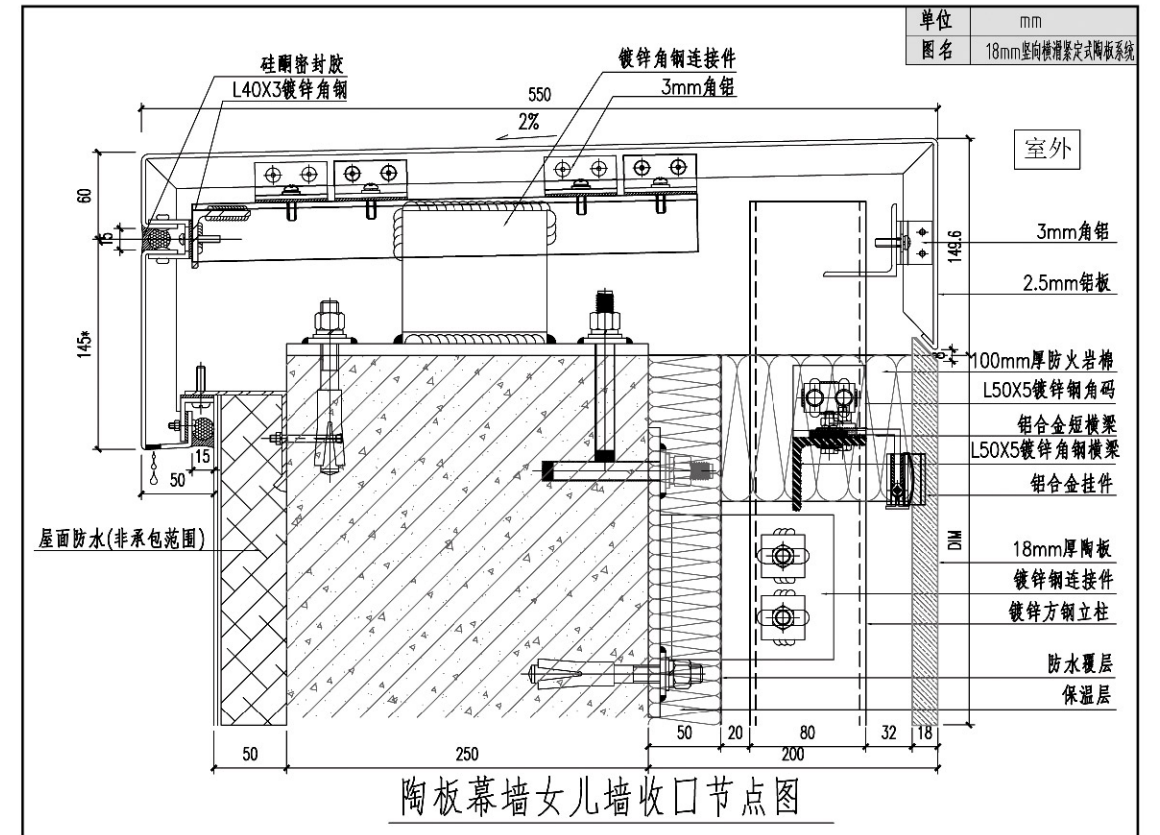

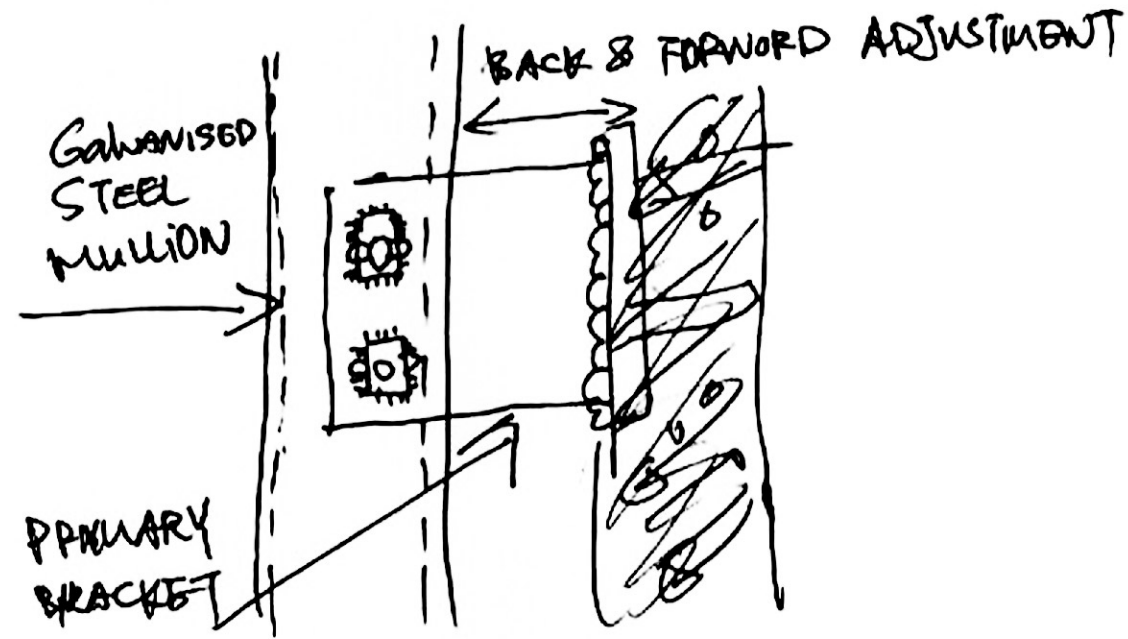

4.
18mm
背栓式竖向系统
安装节点图

4.
18mm
背栓式竖向
系统安装节点图

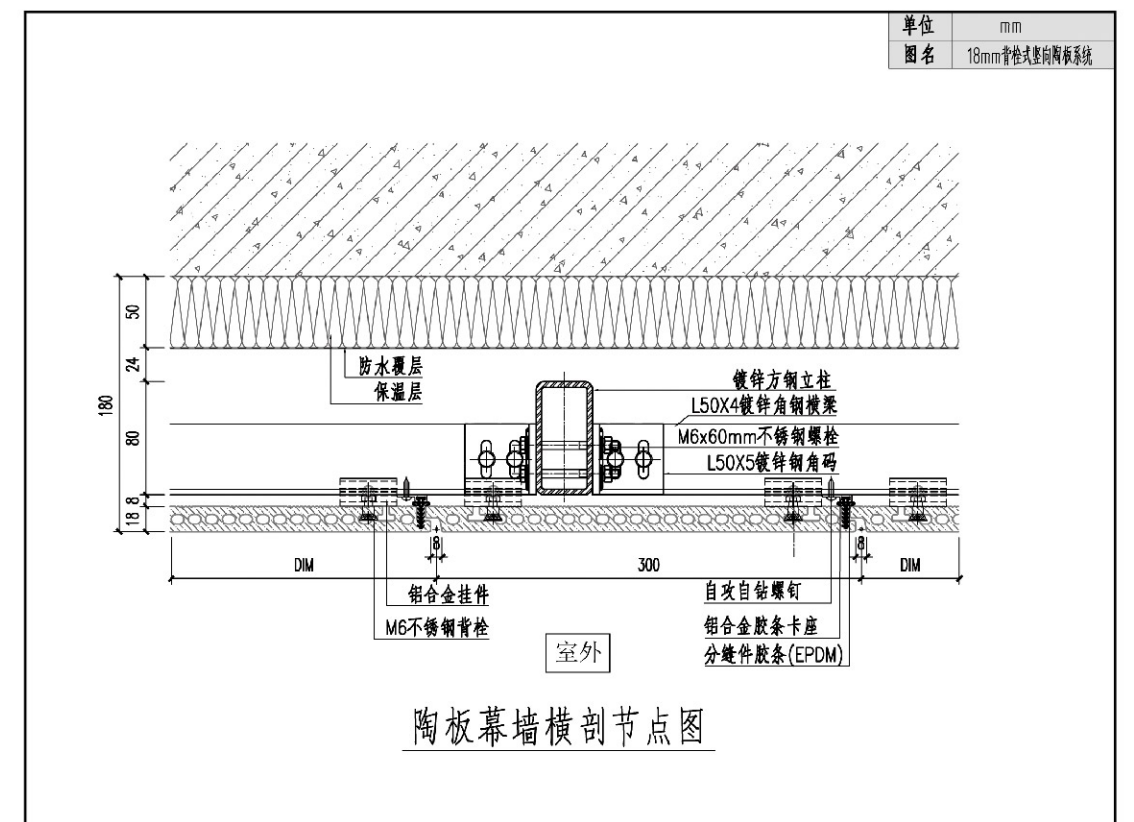
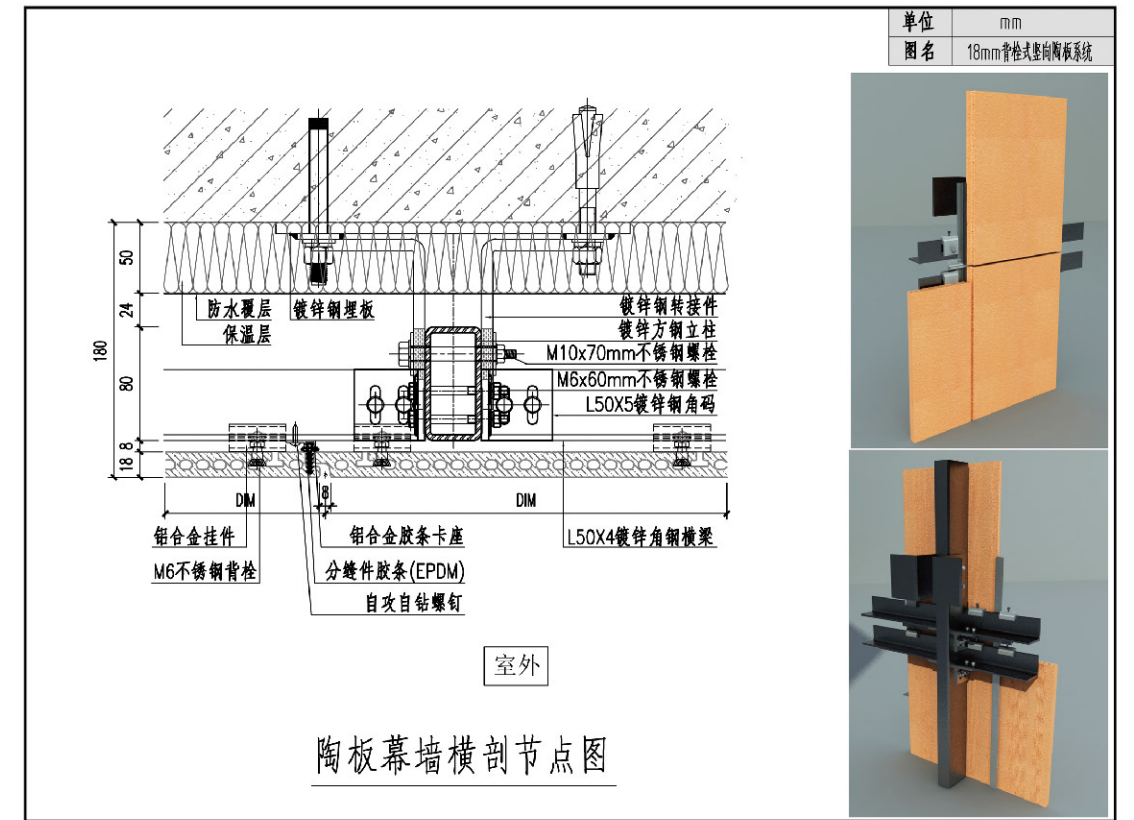

4.

18mm
背栓式竖向
系统安装节点图

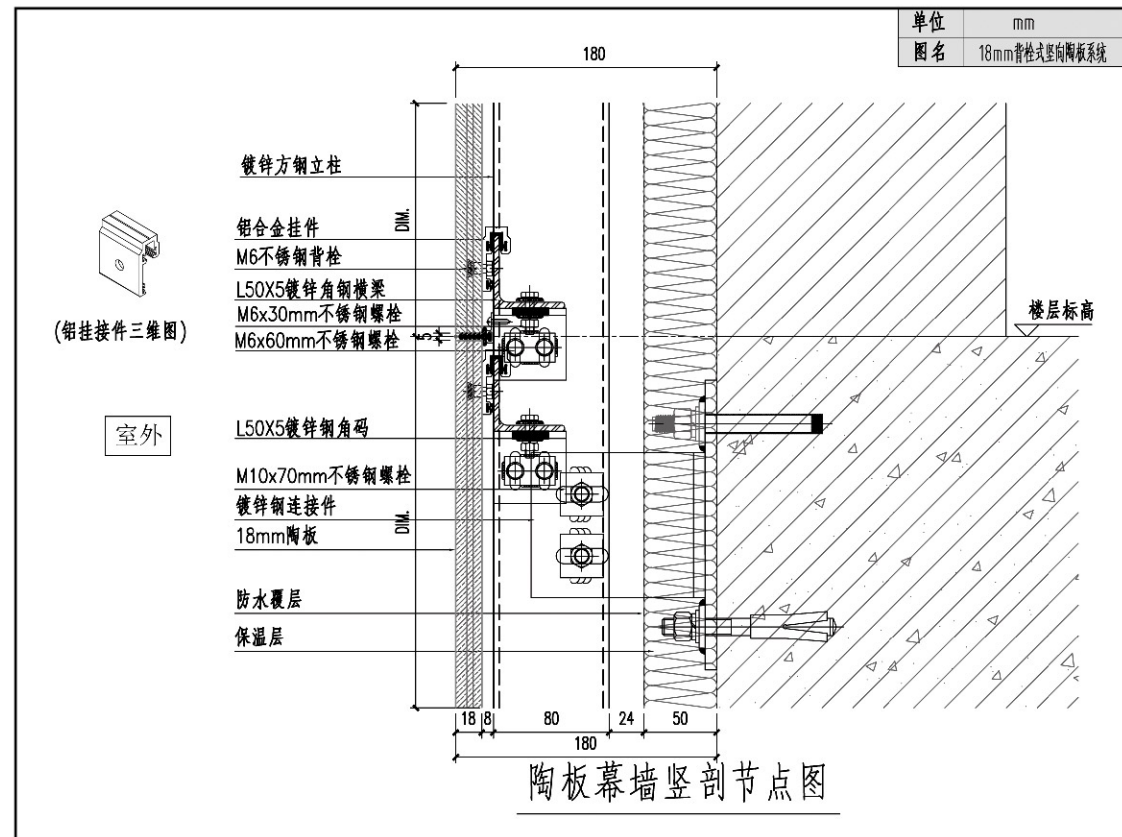

1. 30mm 横向陶板系统(1) 安装节点图

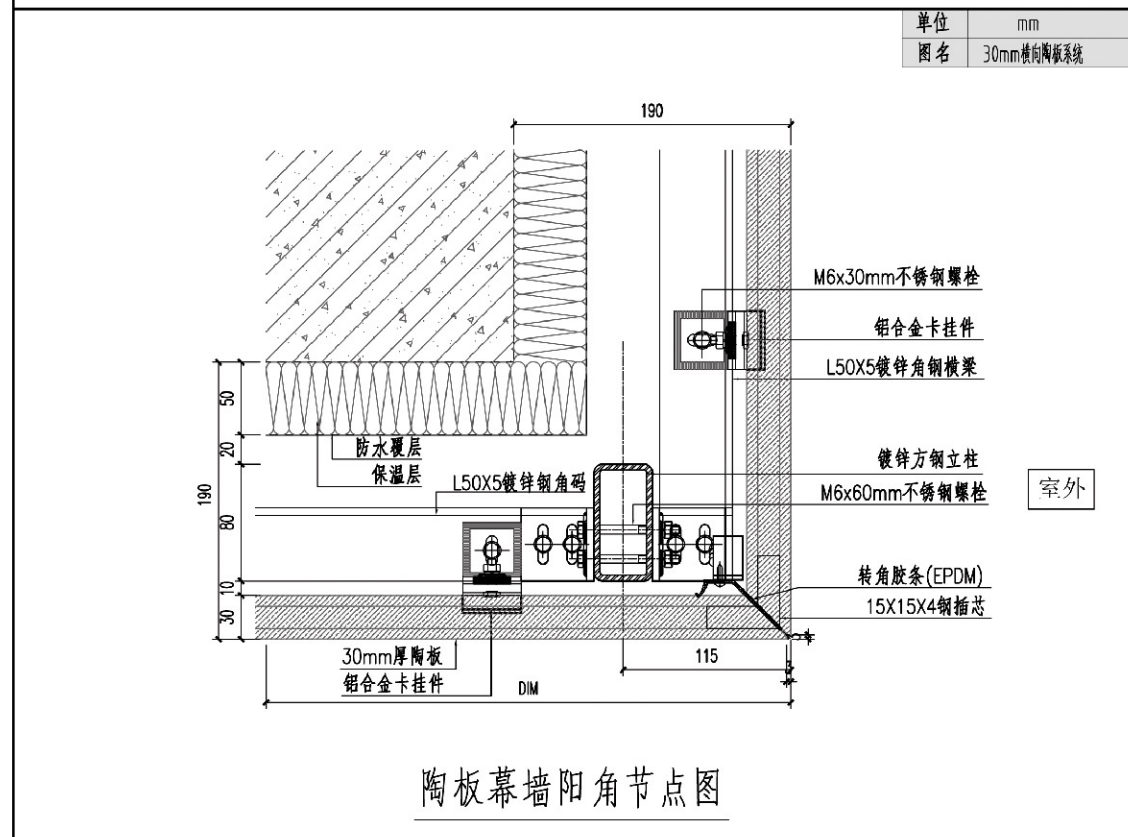
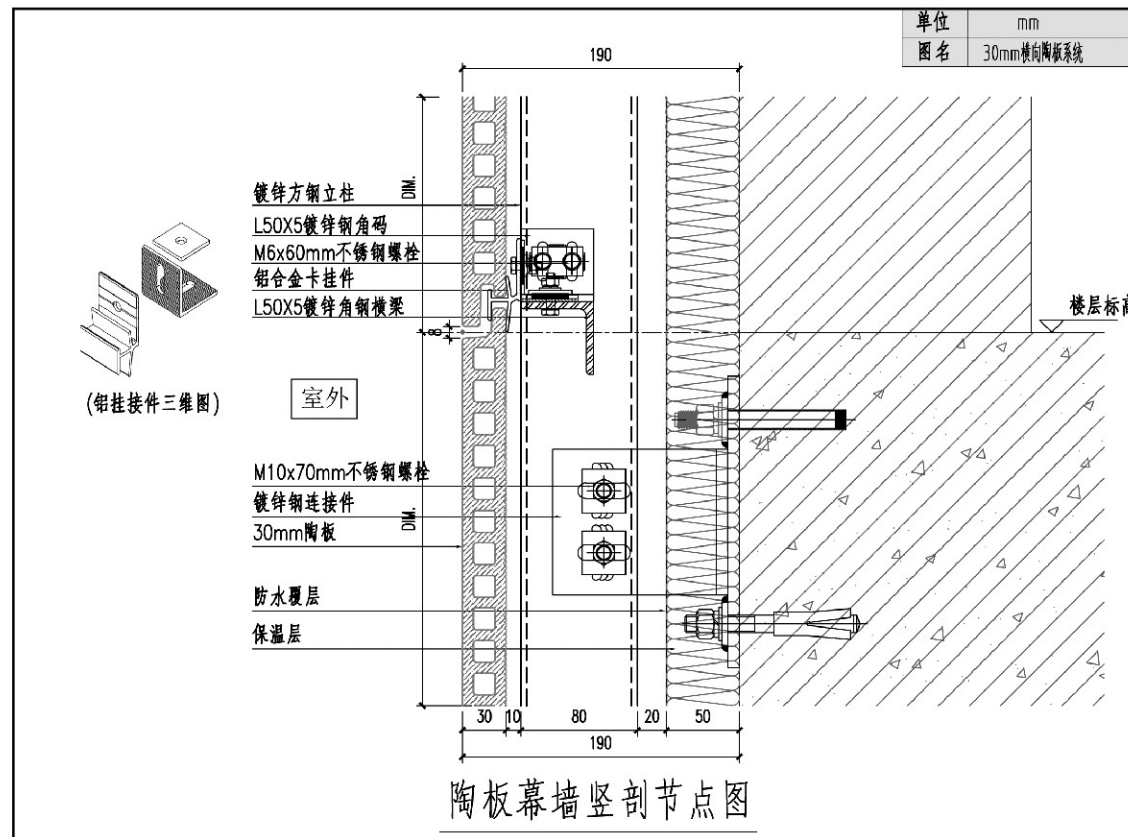

1. 30mm 横向陶板系统(1) 安装节点图

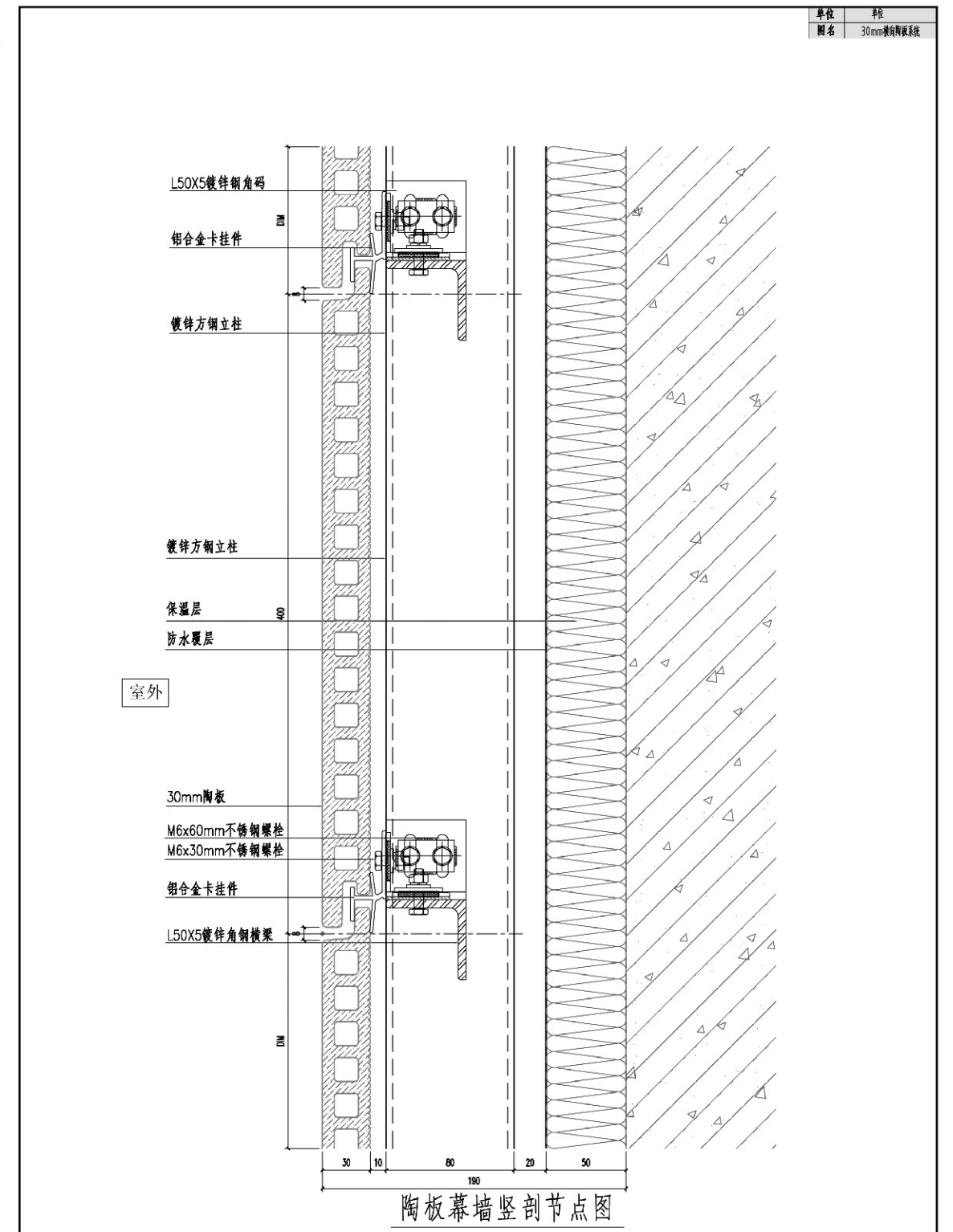

1.
30mm
横向陶板系统(1)
安装节点图

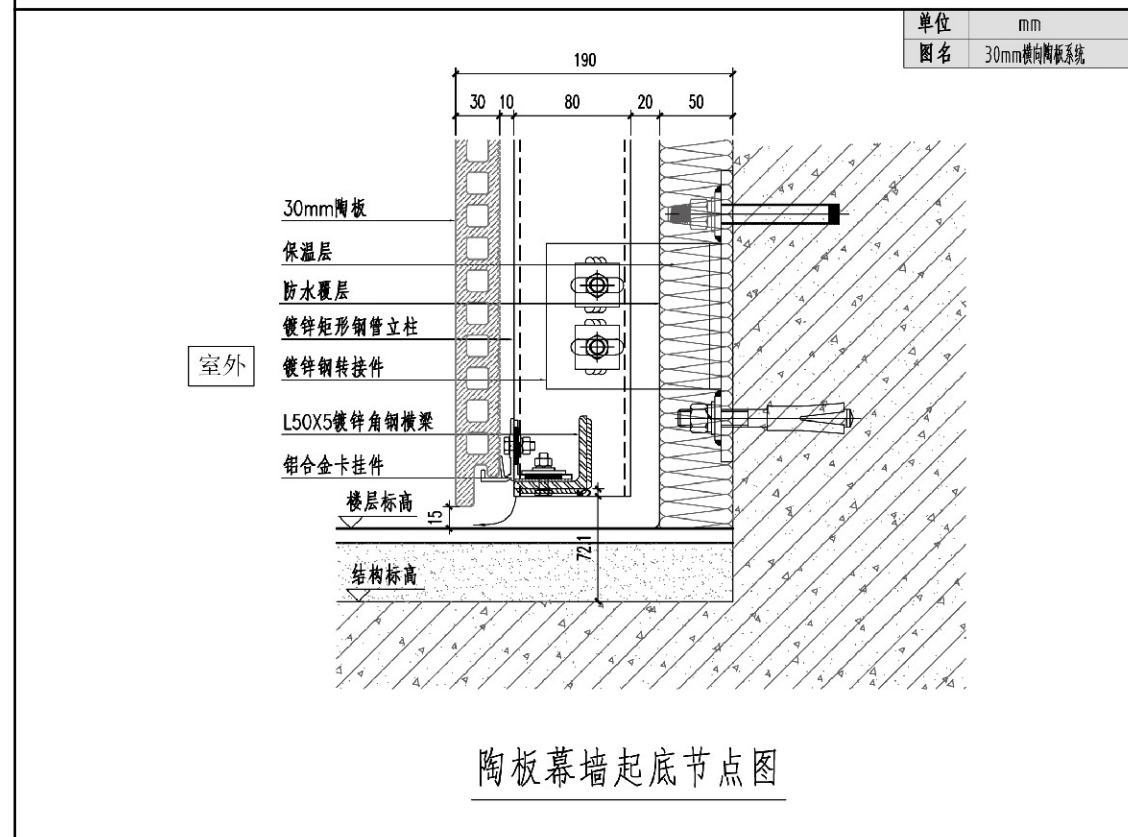
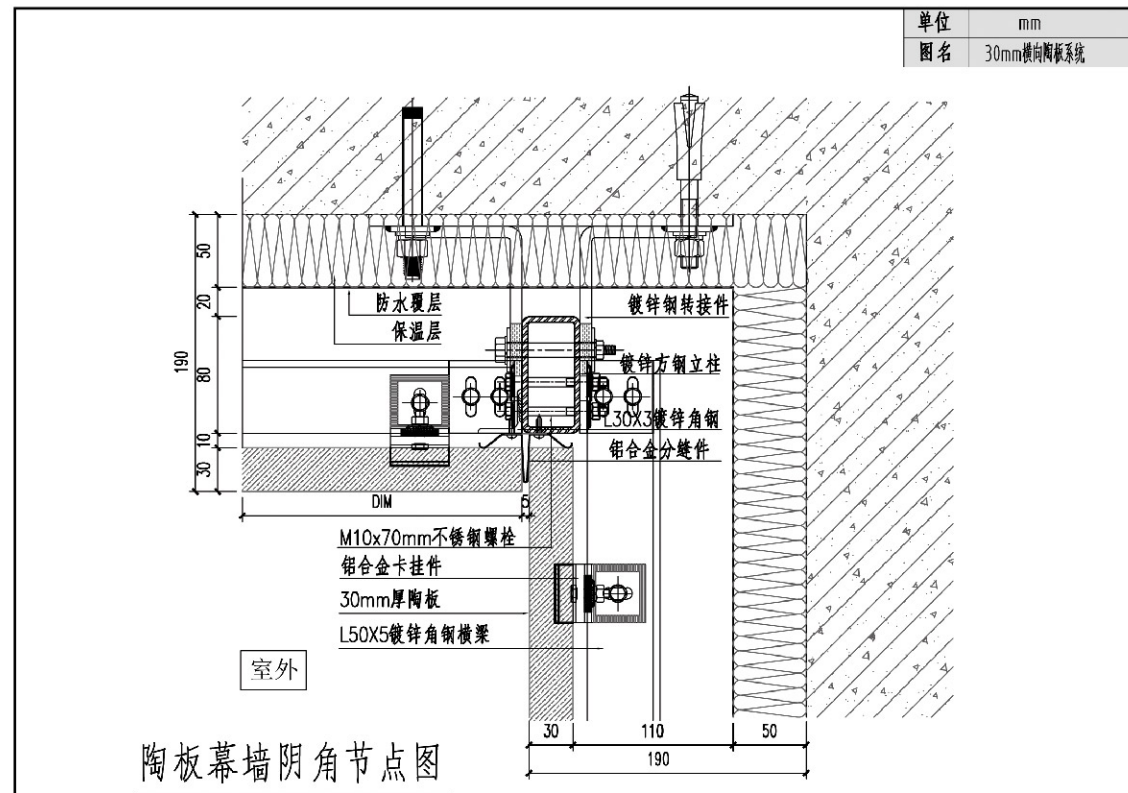

1.
30mm
横向陶板系统(1)
安装节点图

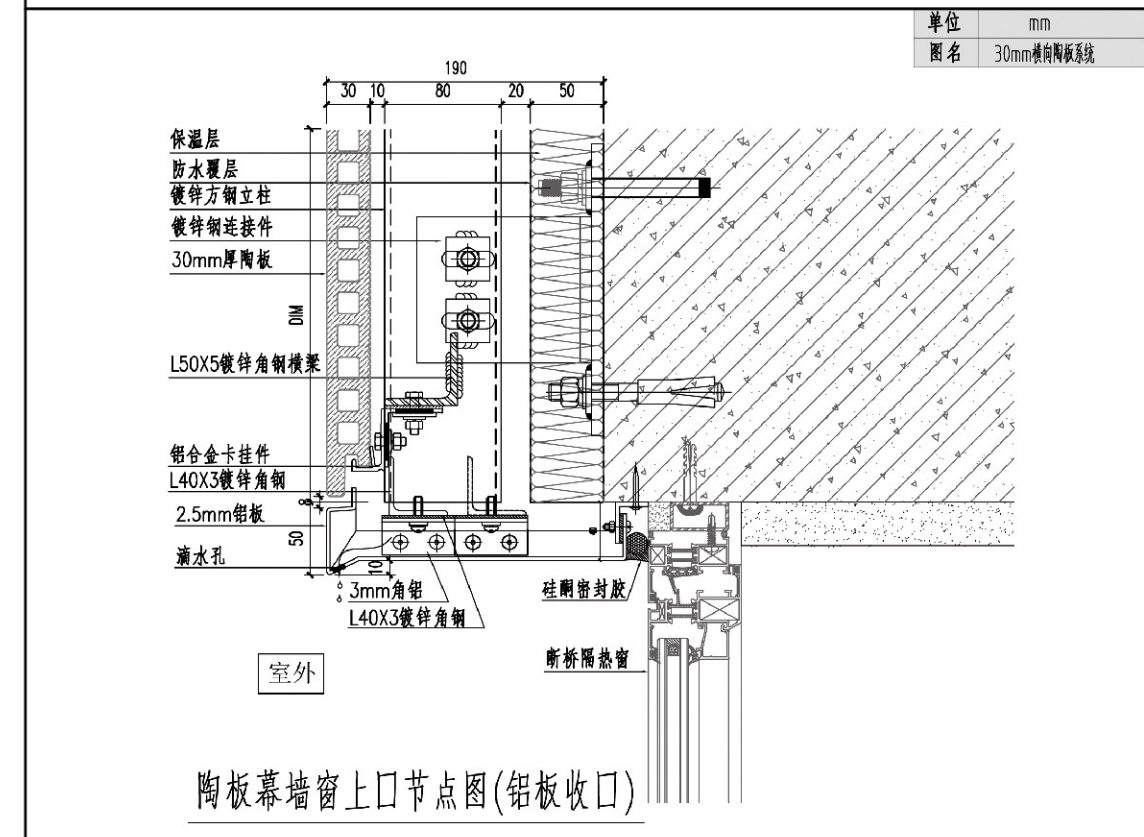
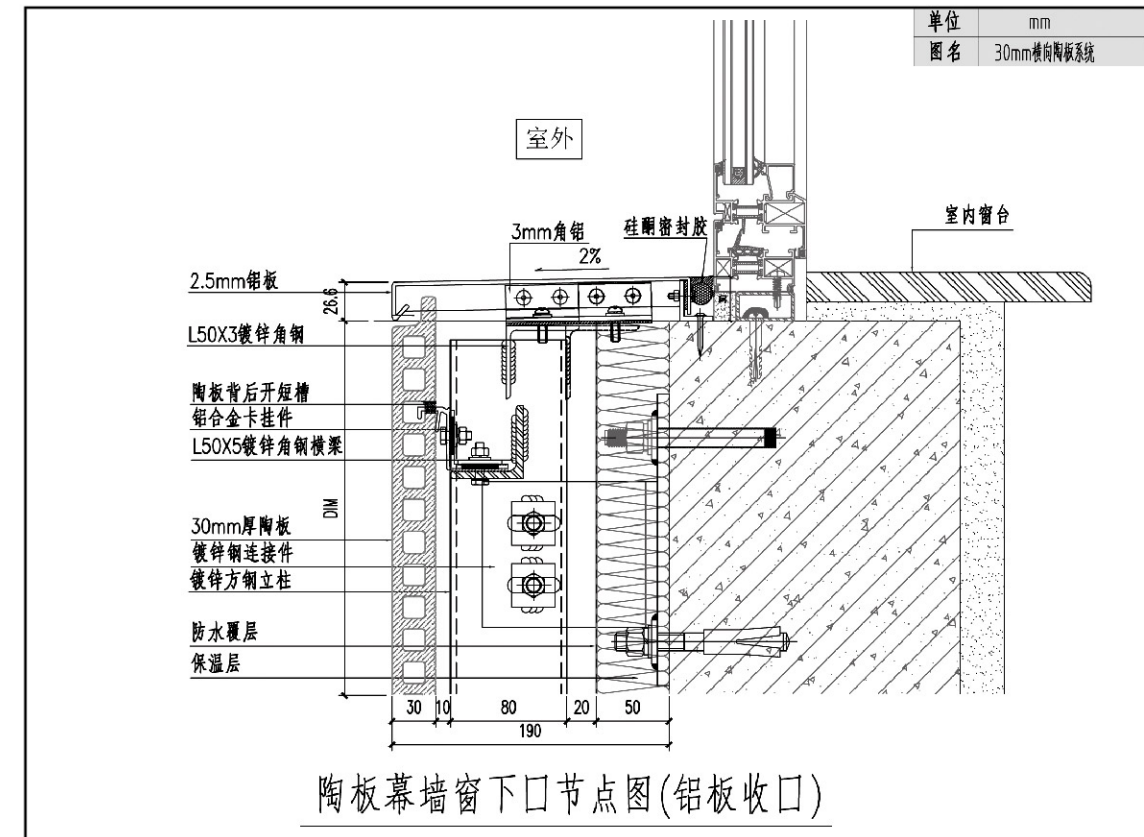

1.
30mm
横向陶板系统(1)
安装节点图

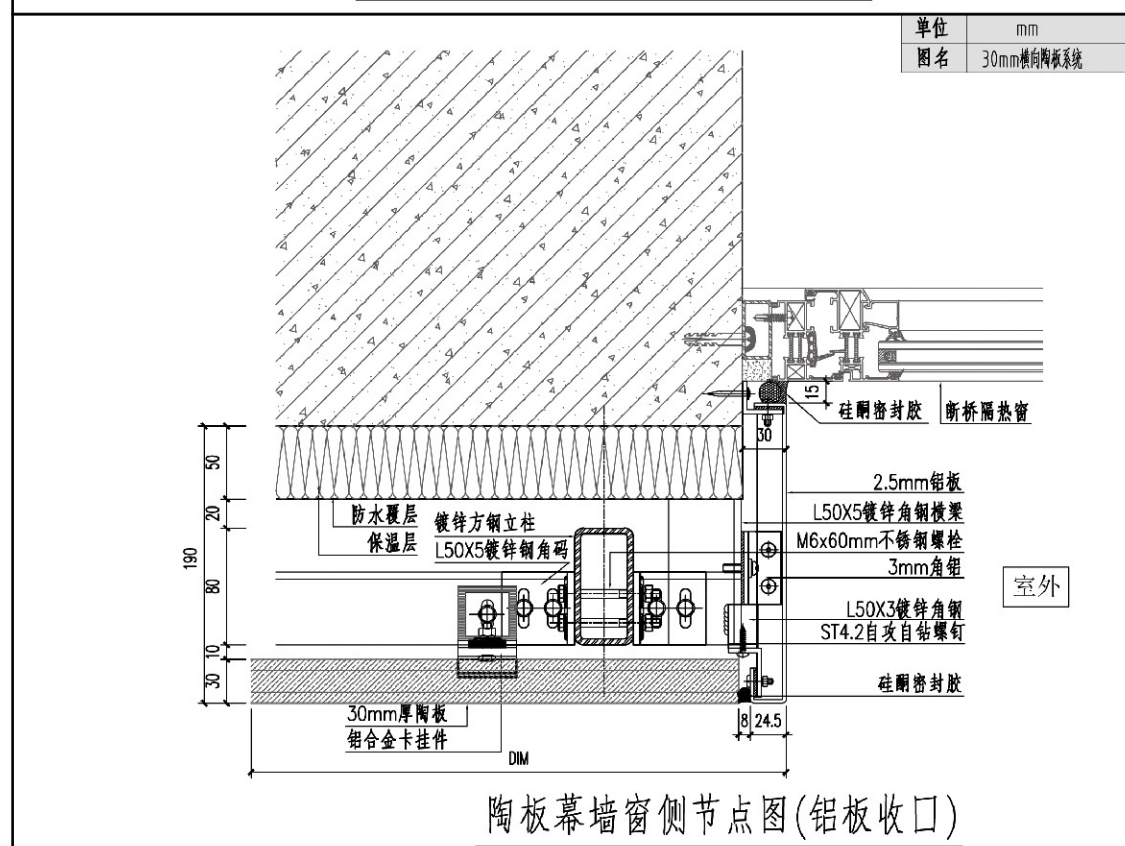
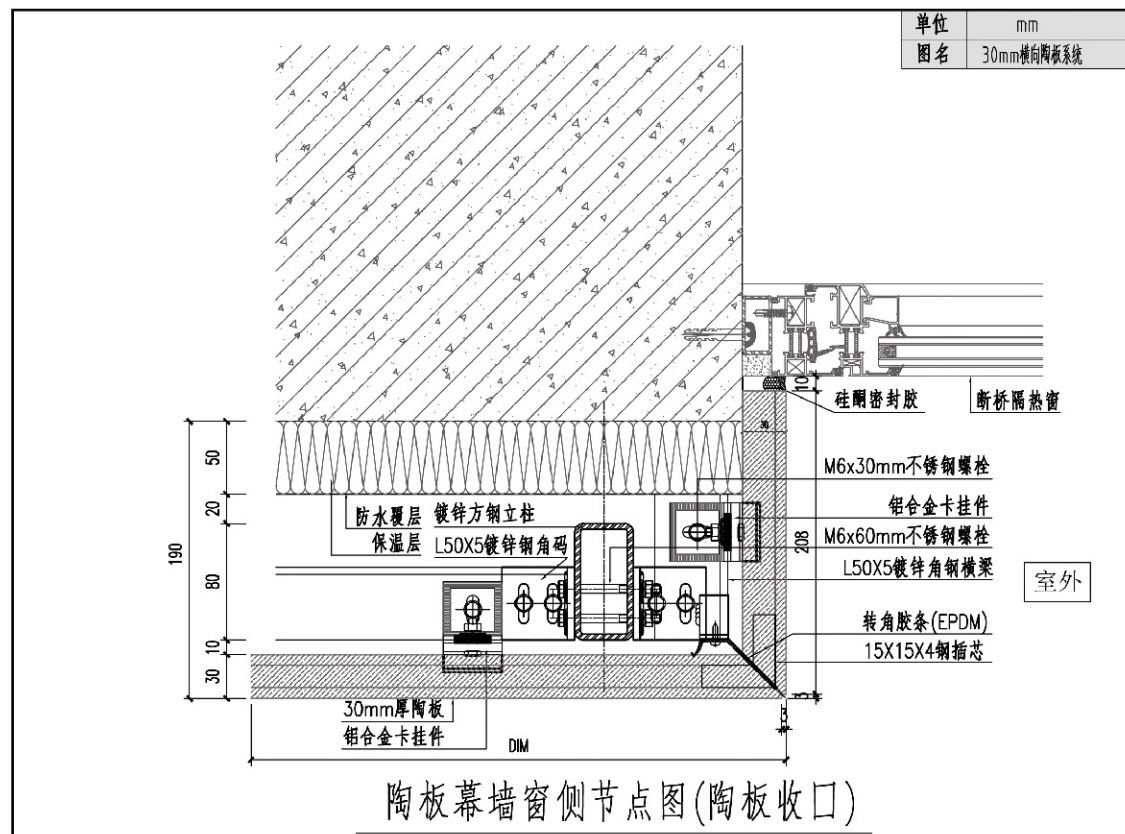

1.
30mm
横向陶板系统(1)
安装节点图

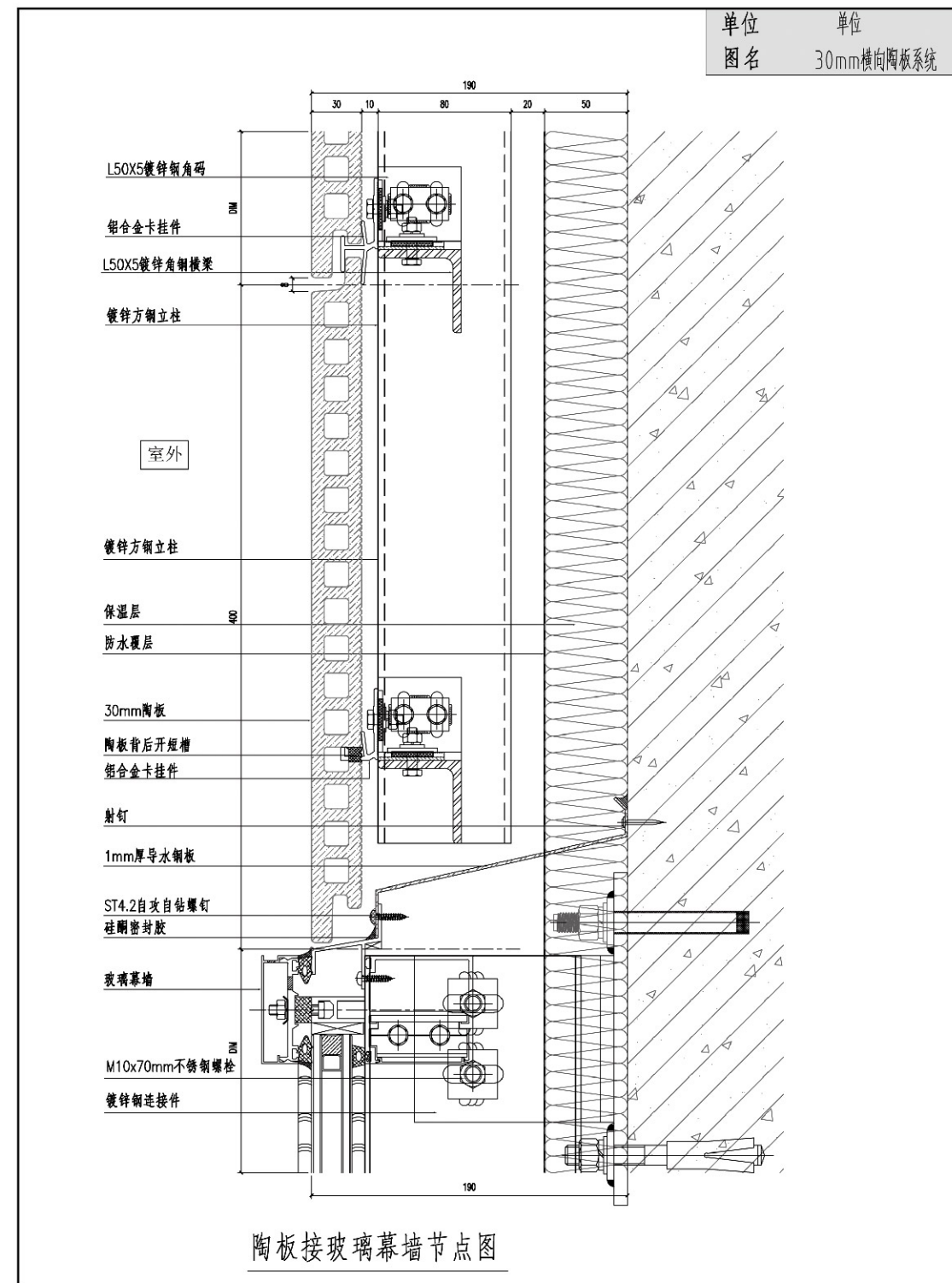

1.
30mm
横向陶板系统(1)
安装节点图

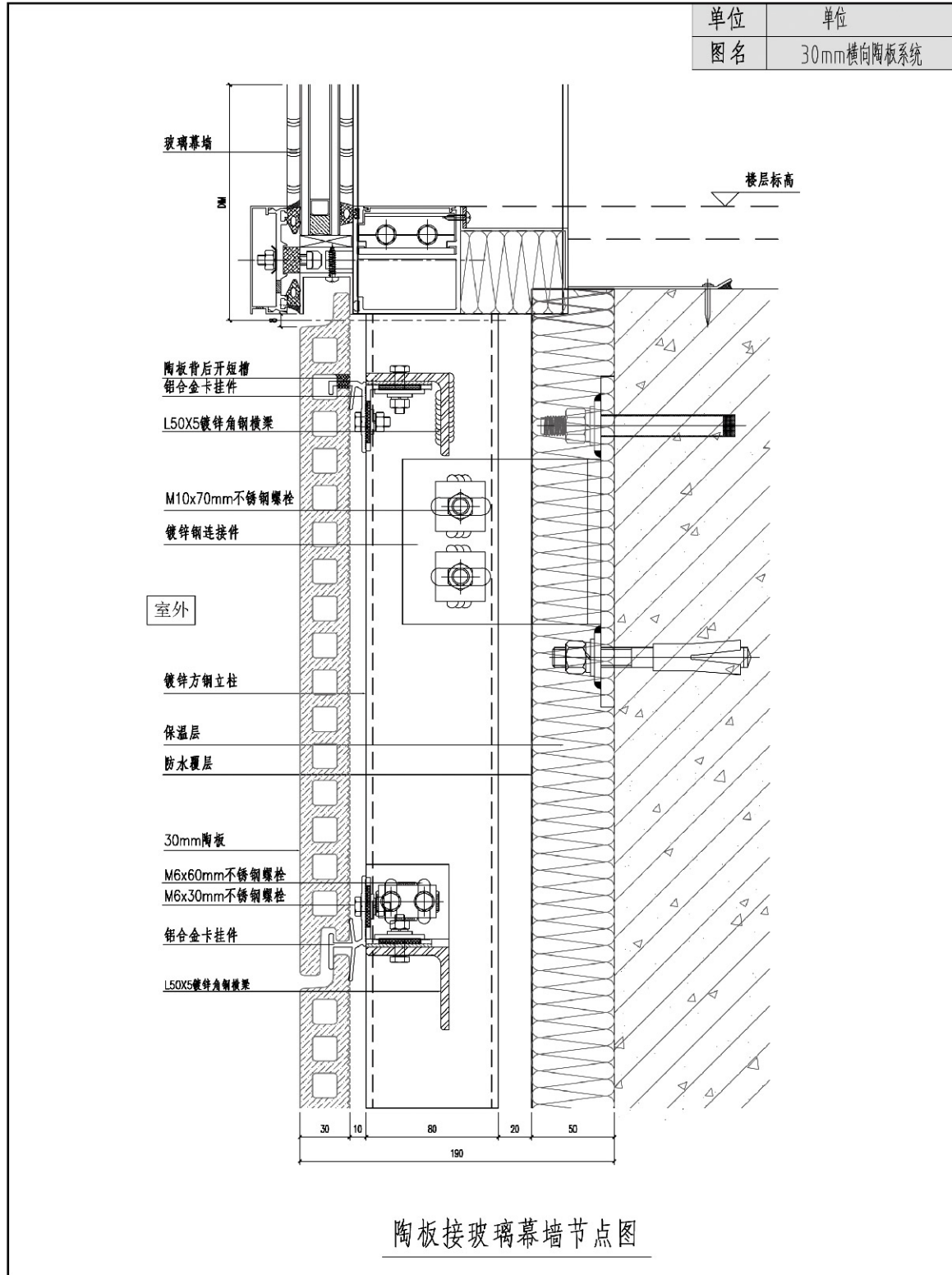

1.
30mm
横向陶板系统(1)
安装节点图

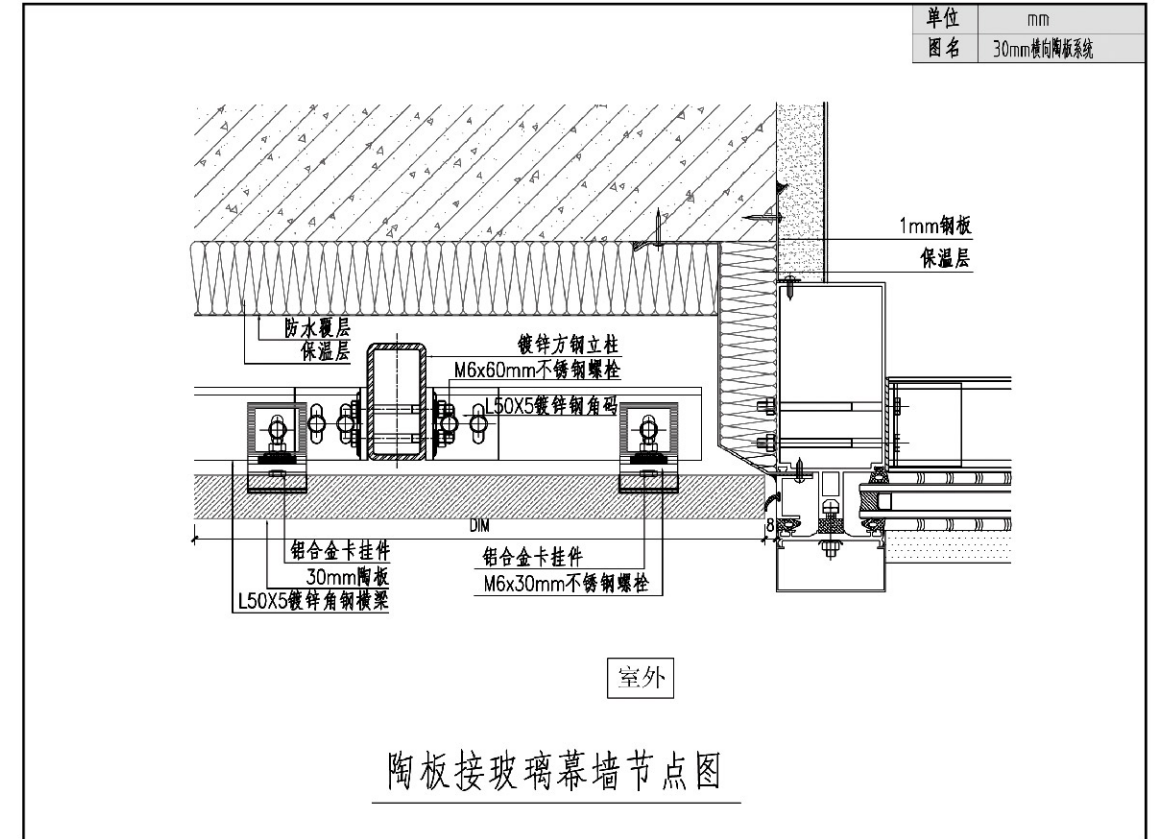

1.
30mm
横向陶板系统(2)
安装节点图

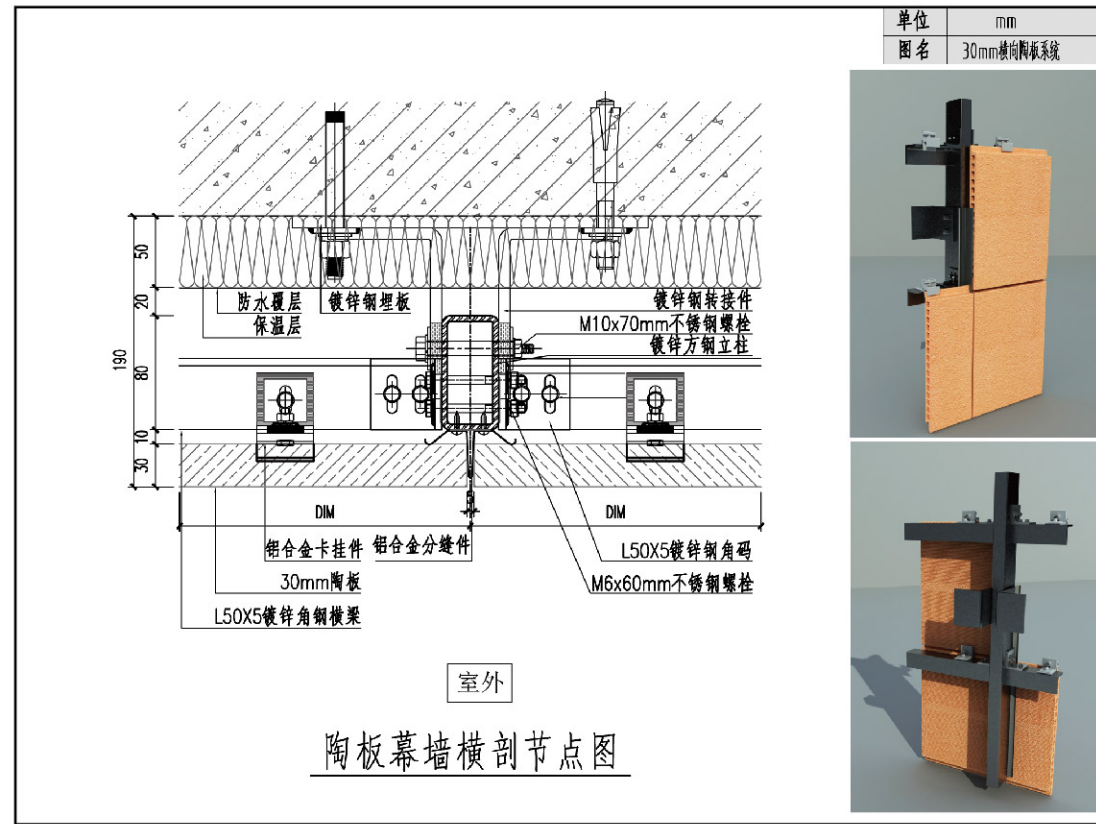

1.
30mm
横向陶板系统(2)
安装节点图

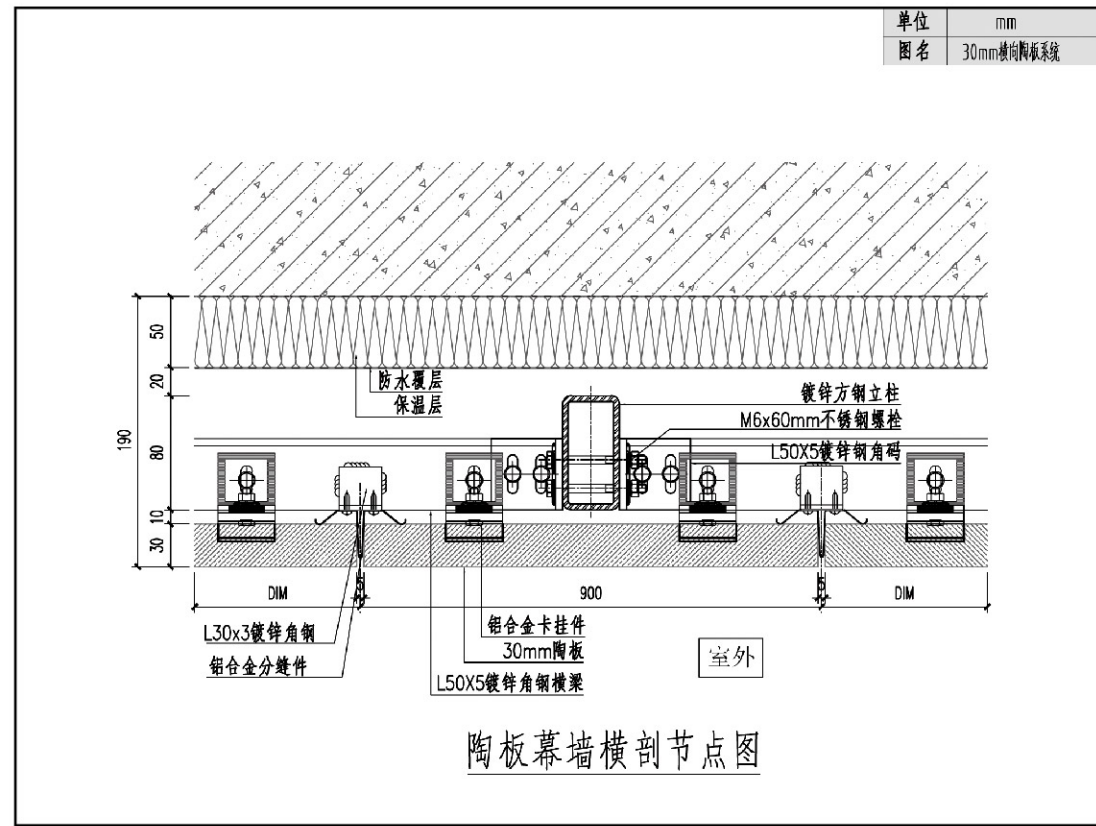
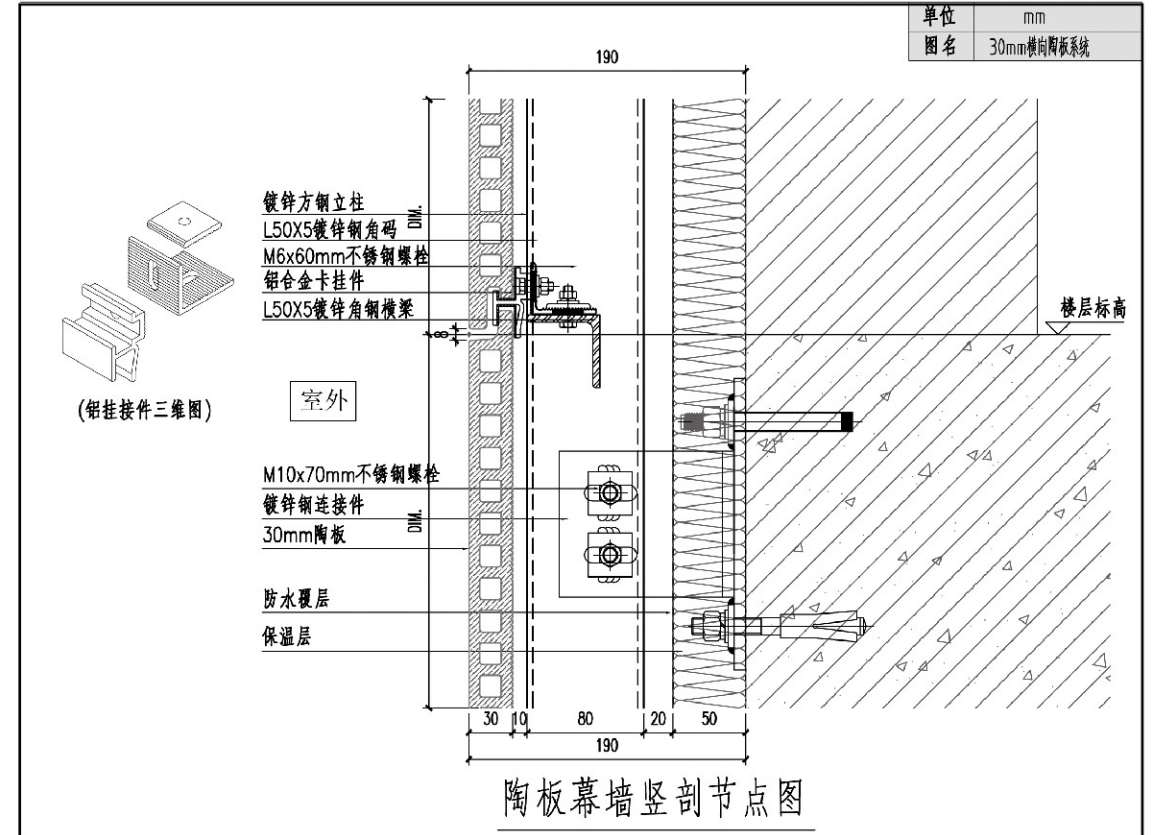

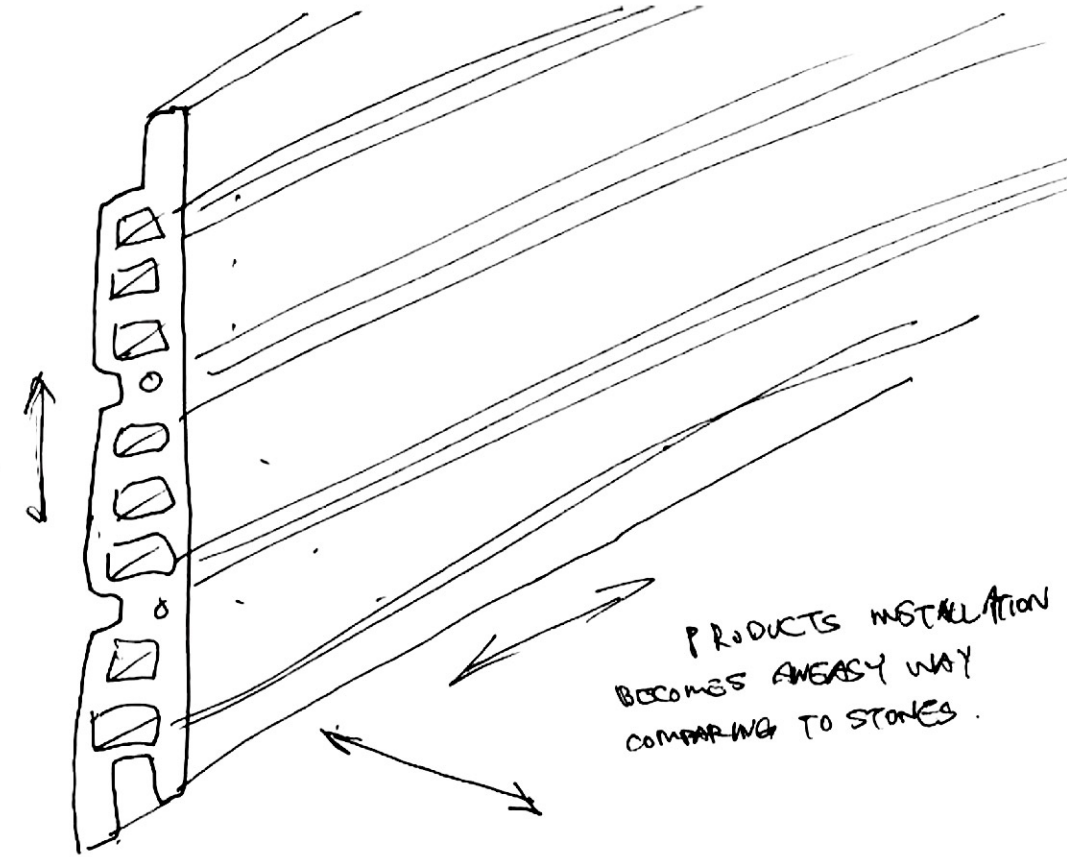

2.

30mm 竖向陶板系统 安装节点图

2.

30mm
竖向陶板系统
安装节点图

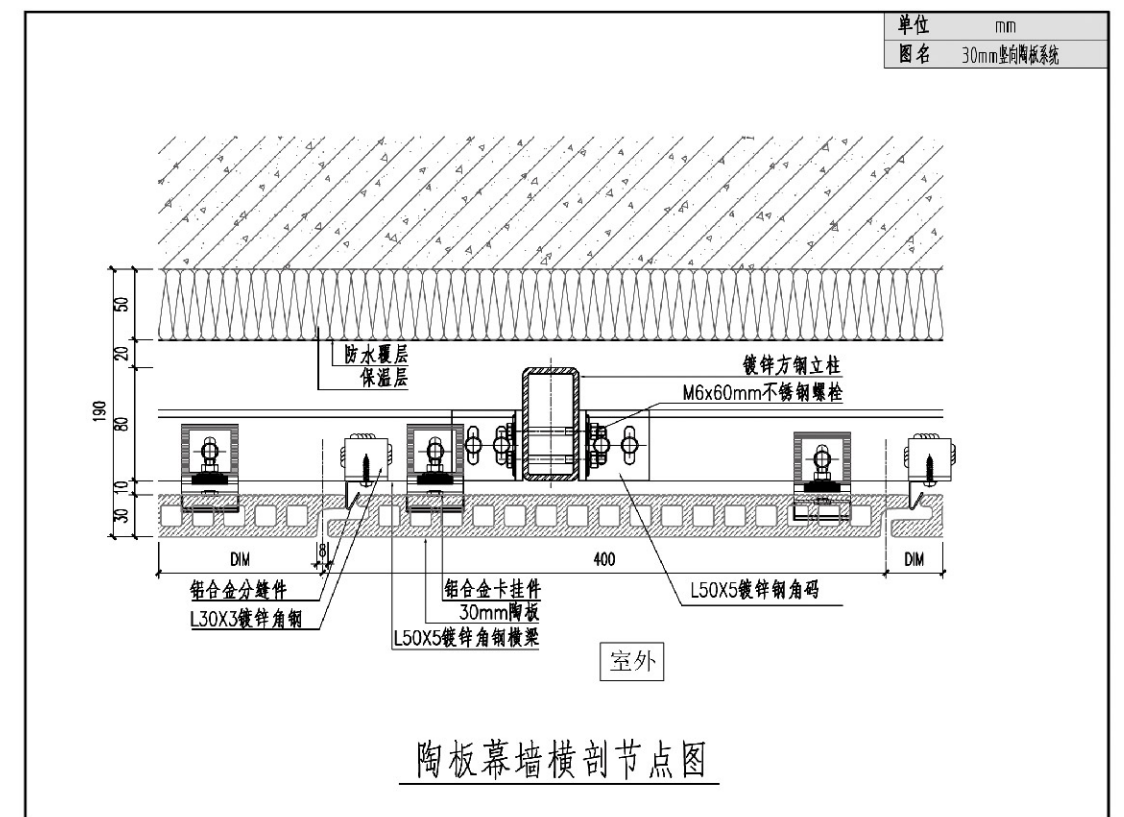
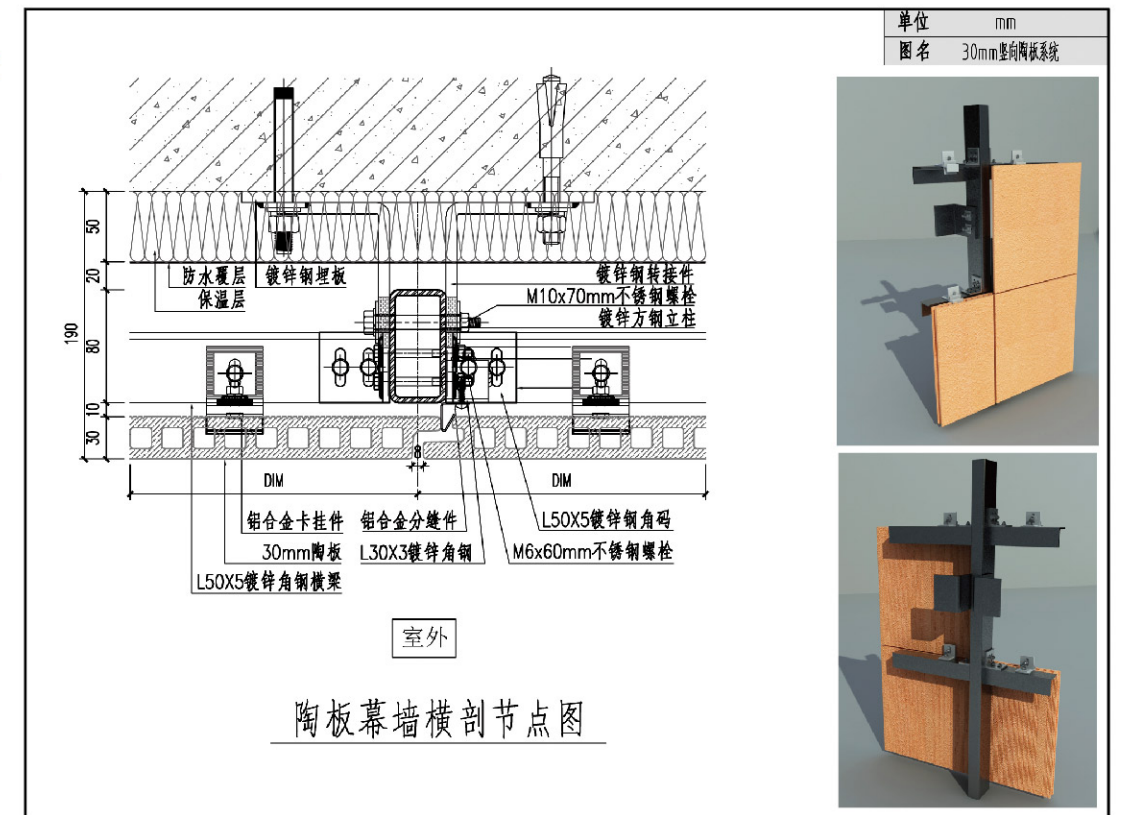

2.
30mm
竖向陶板系统
安装节点图

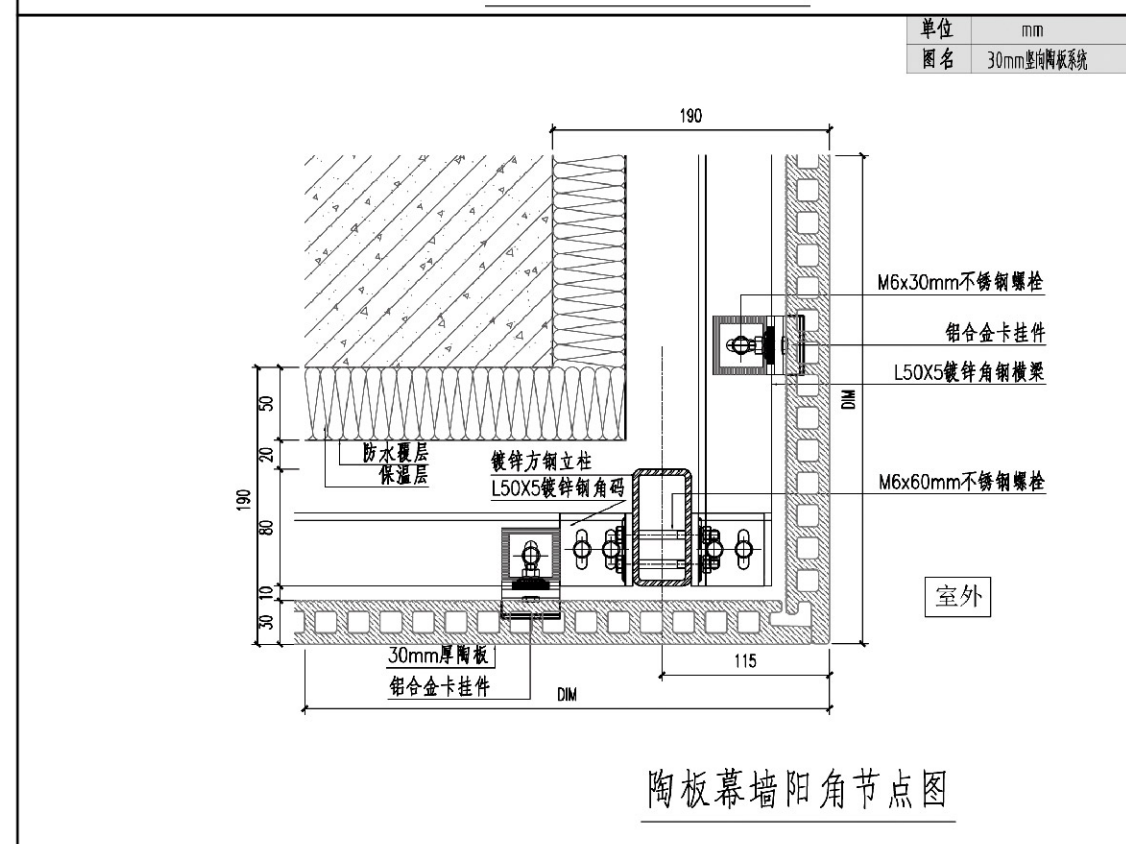
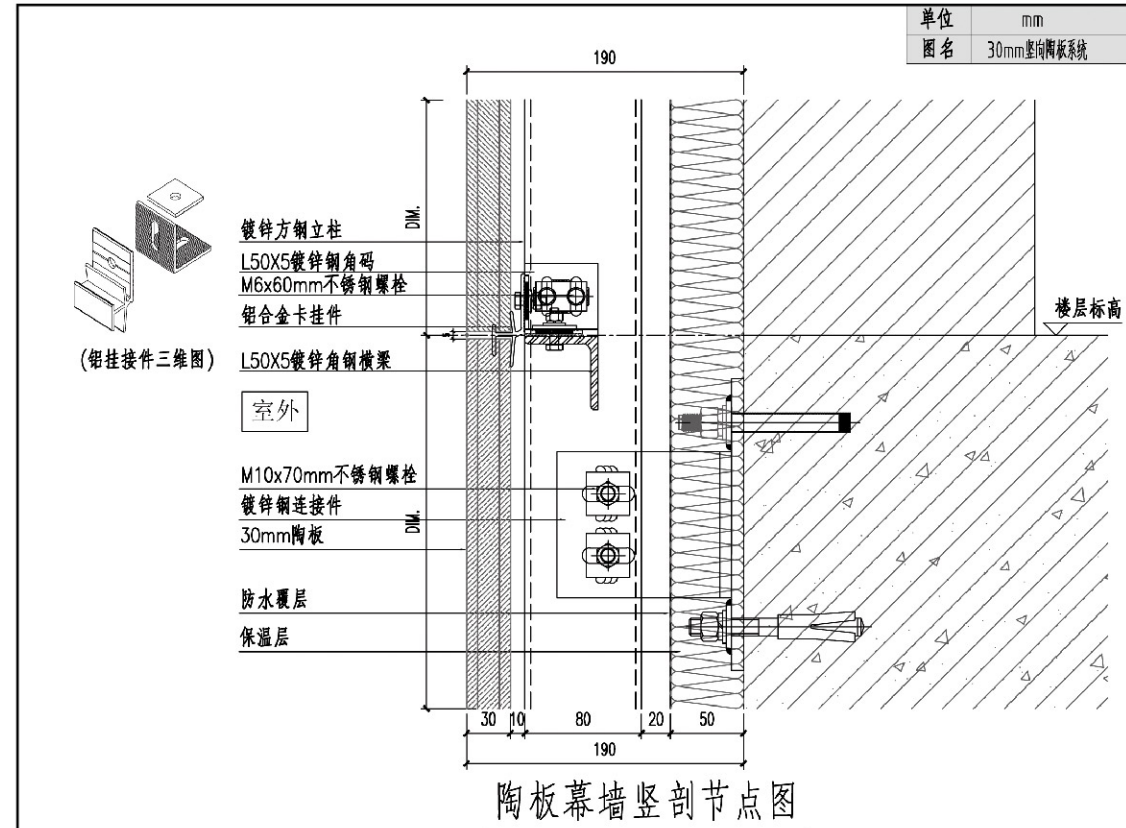

2.
30mm
竖向陶板系统
安装节点图

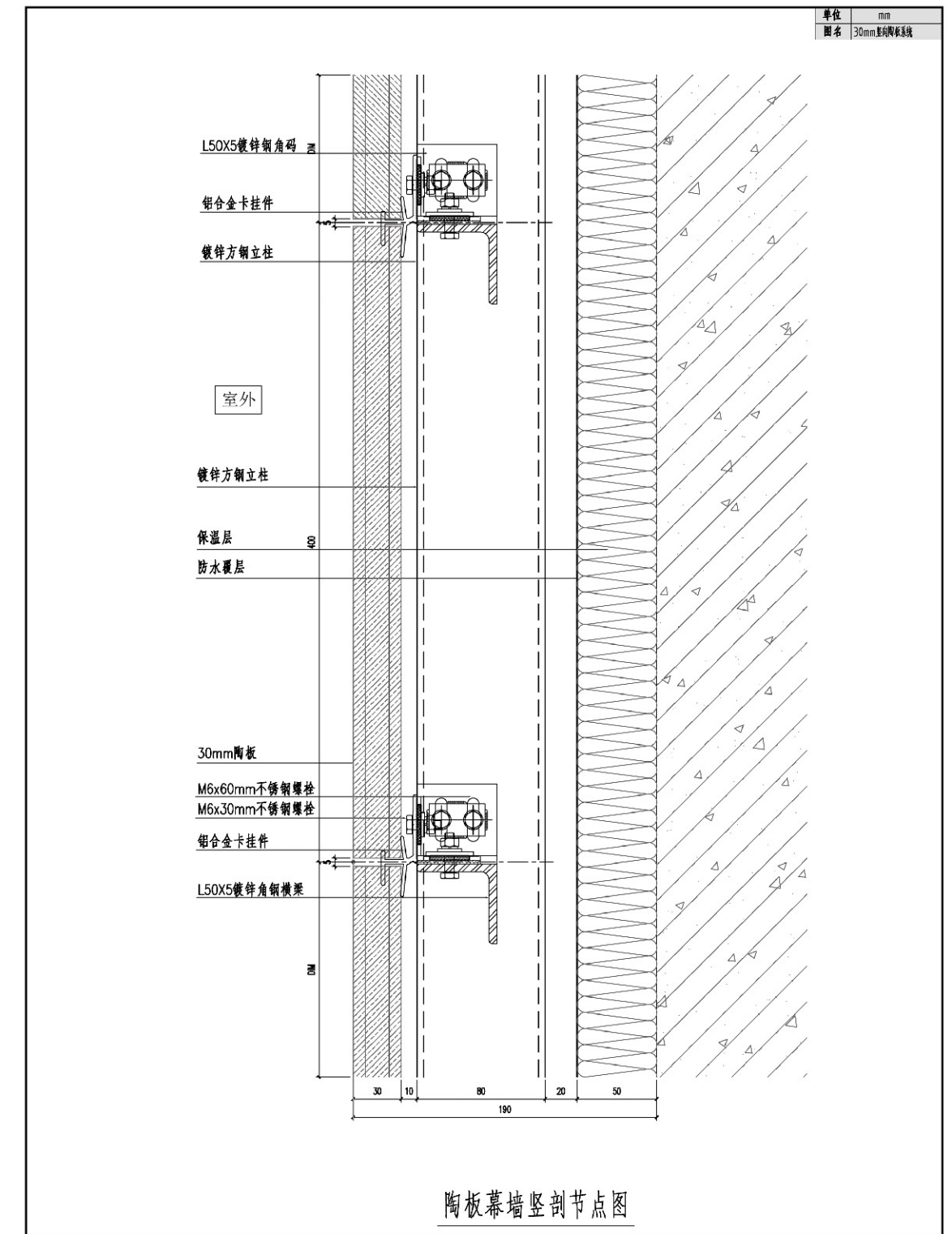

2.

30mm
竖向陶板系统
安装节点图

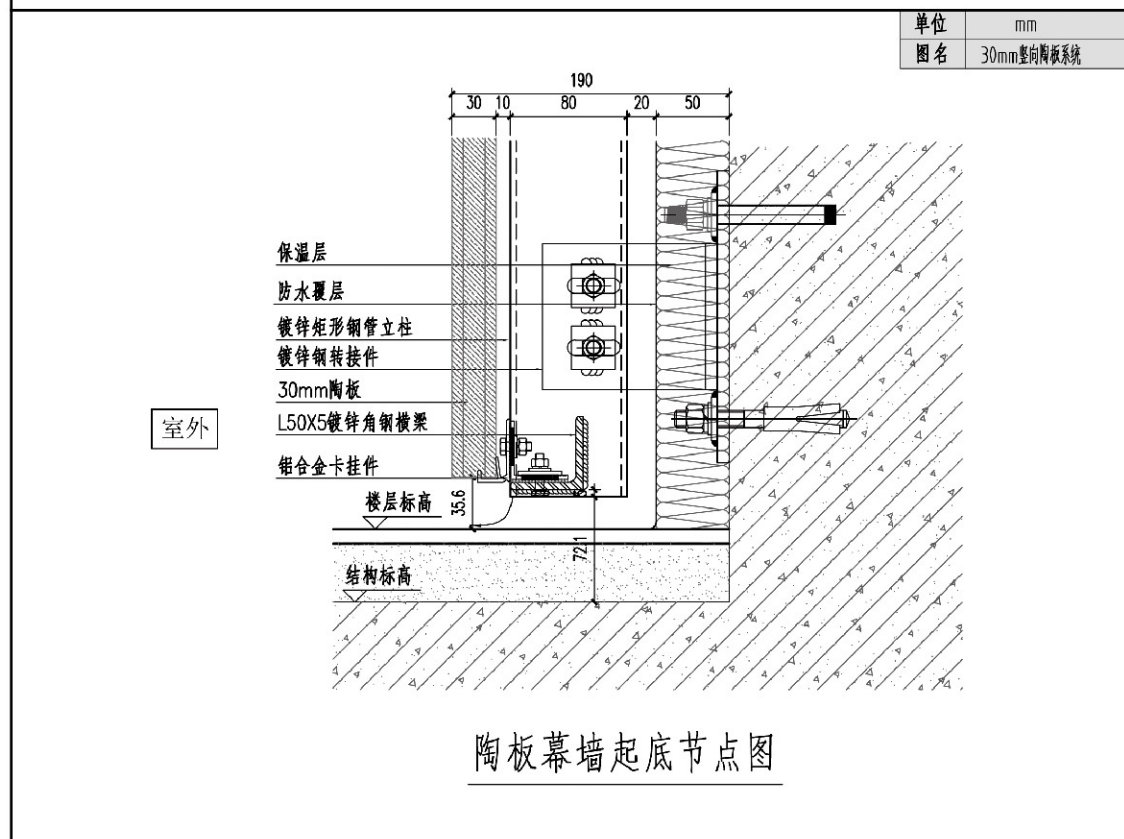
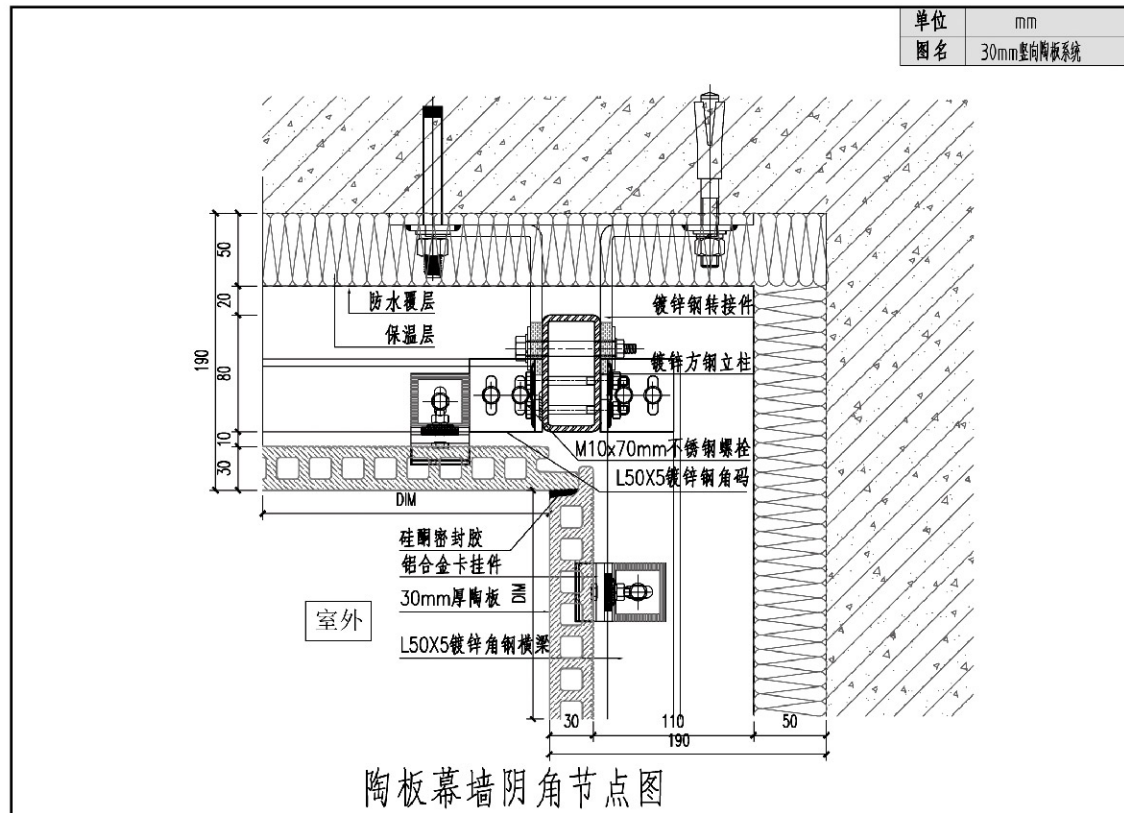

2.

30mm
竖向陶板系统
安装节点图

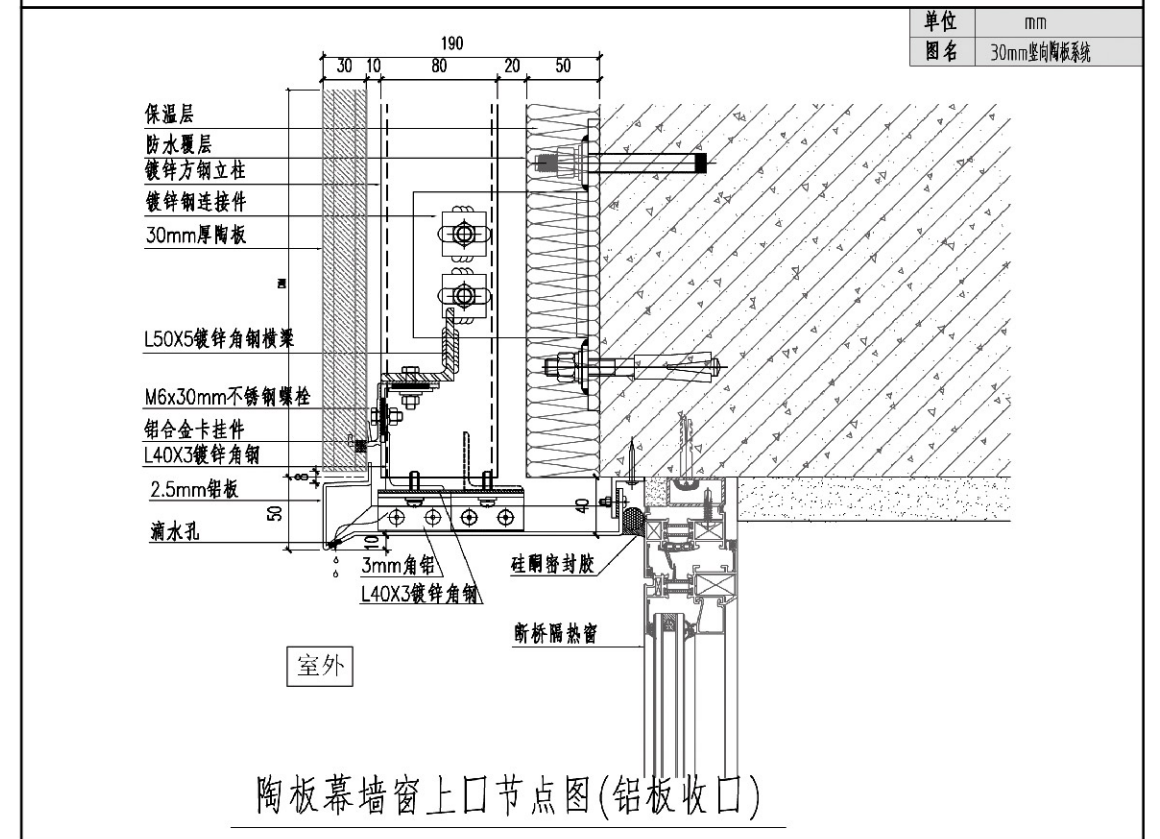
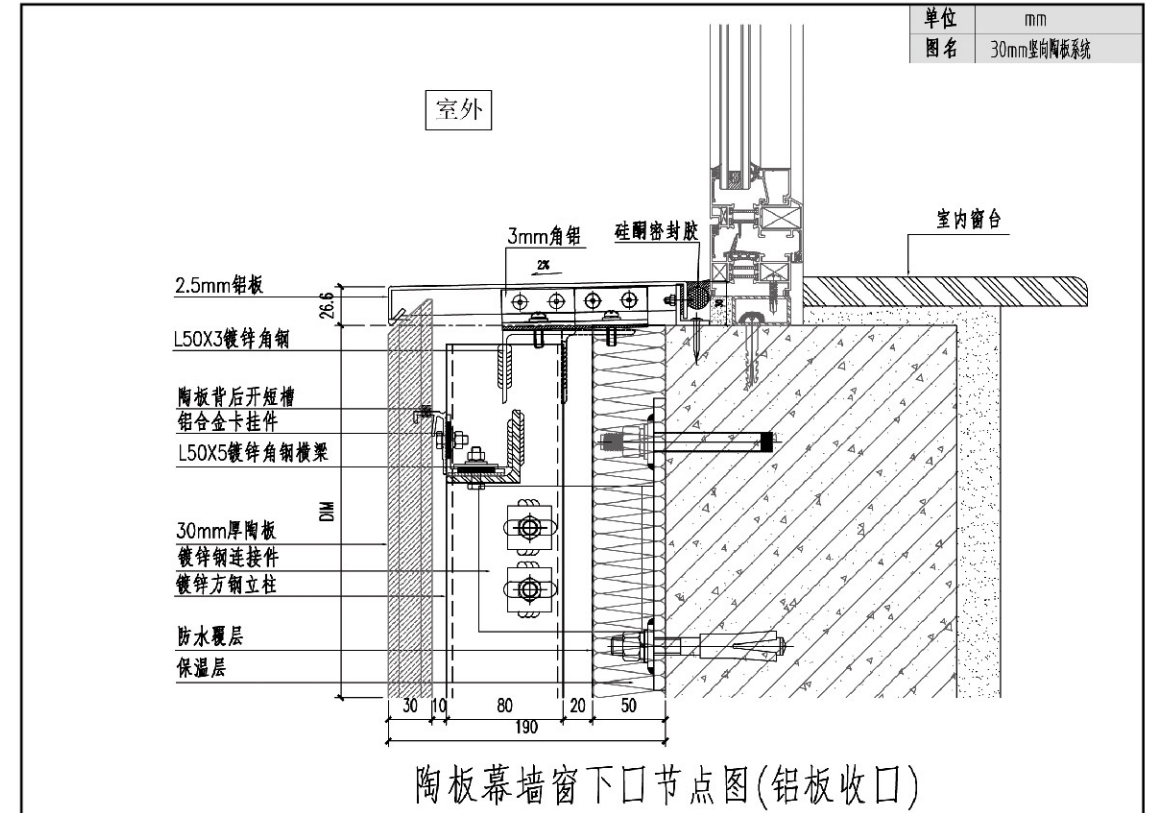

2.

30mm
竖向陶板系统
安装节点图

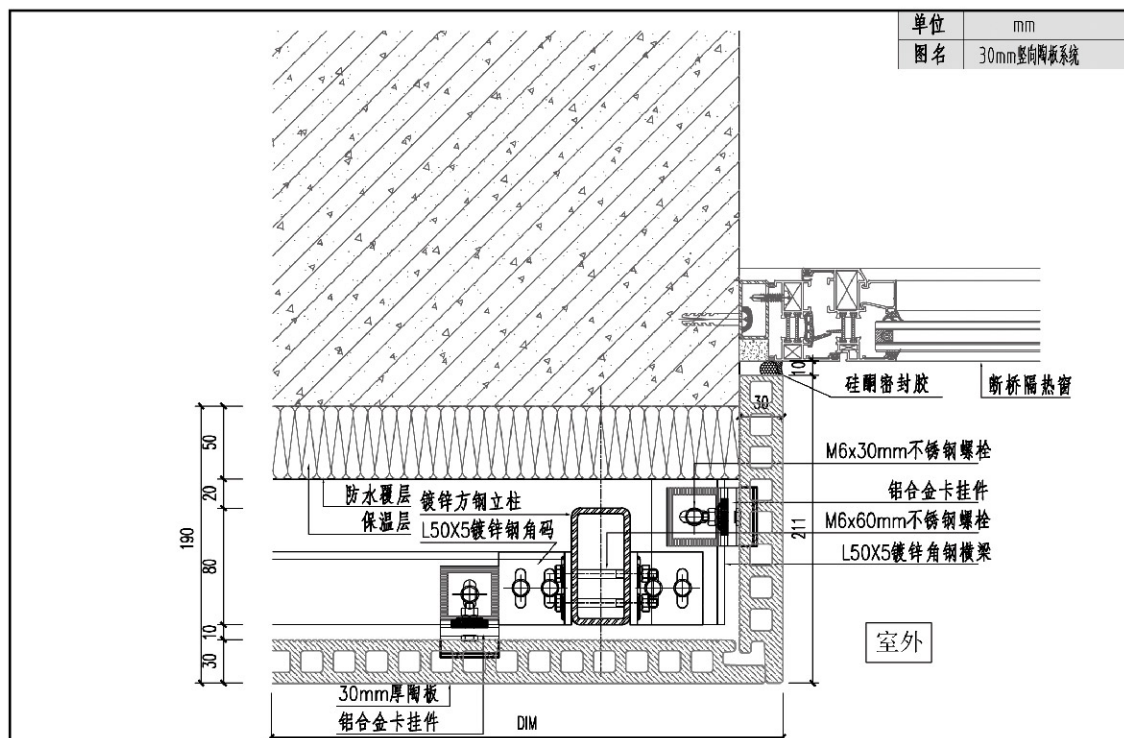

陶板幕墙窗侧节点图(陶板收口)

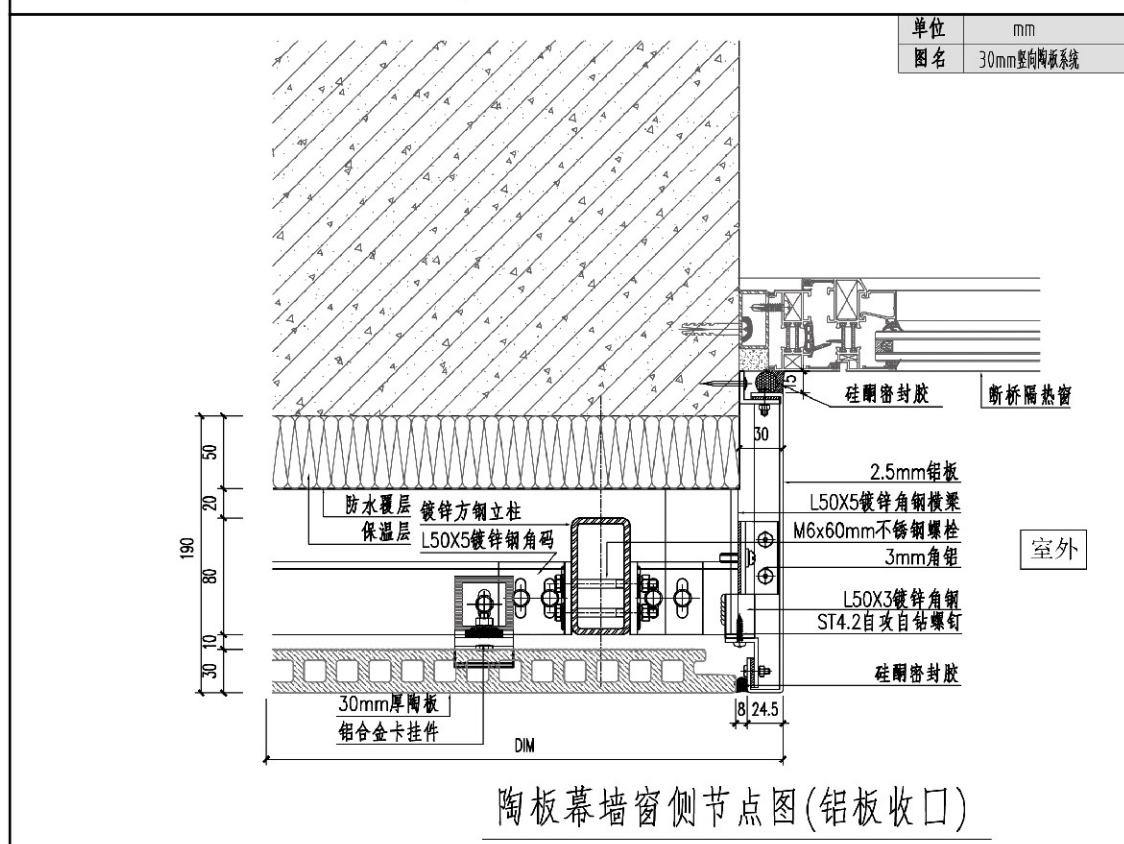

陶板幕墙窗侧节点图(铝板收口)

2.

30mm
竖向陶板系统
安装节点图

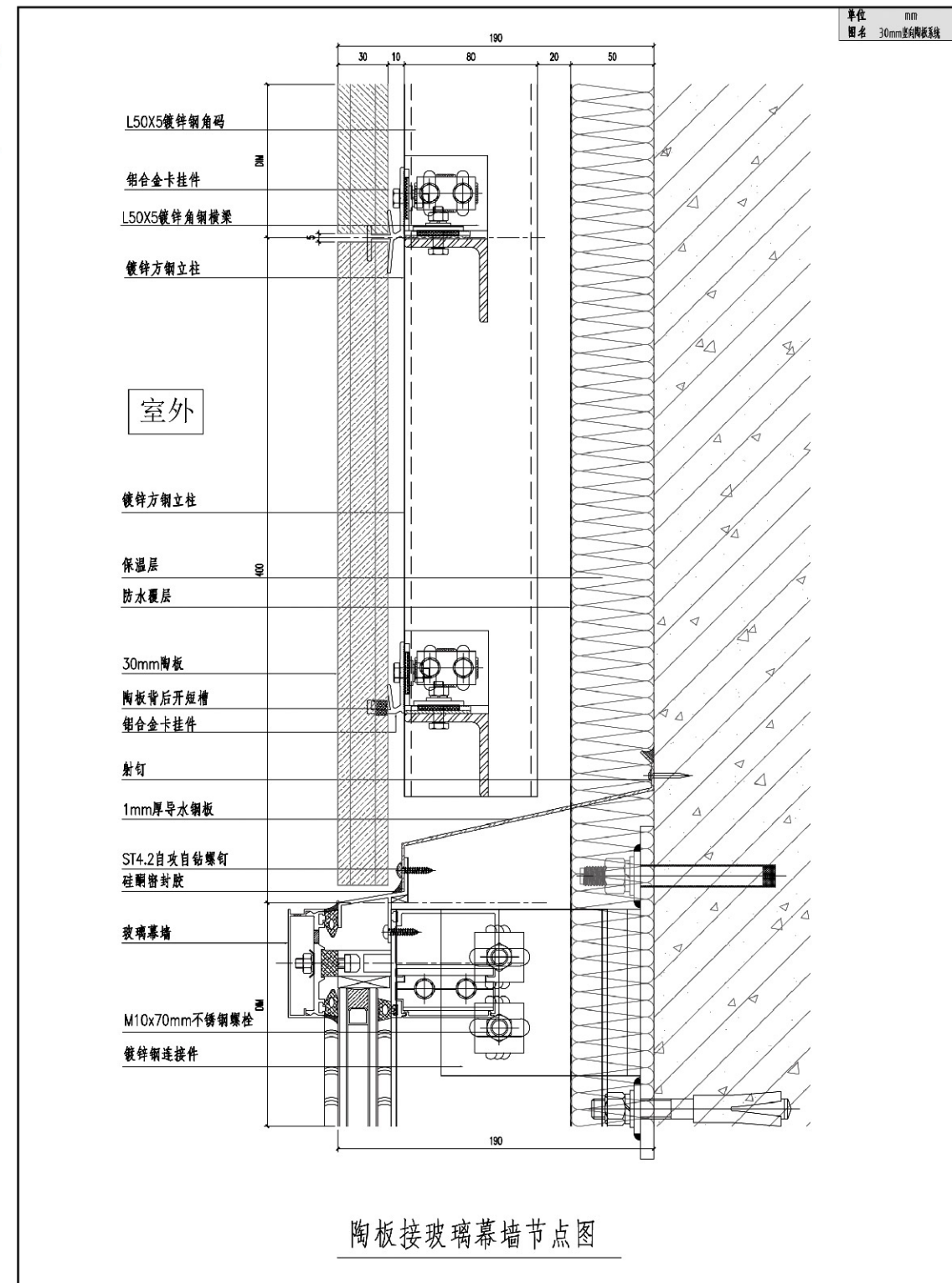

陶板接玻璃幕墙节点图

2. 30mm 竖向陶板系统 安装节点图

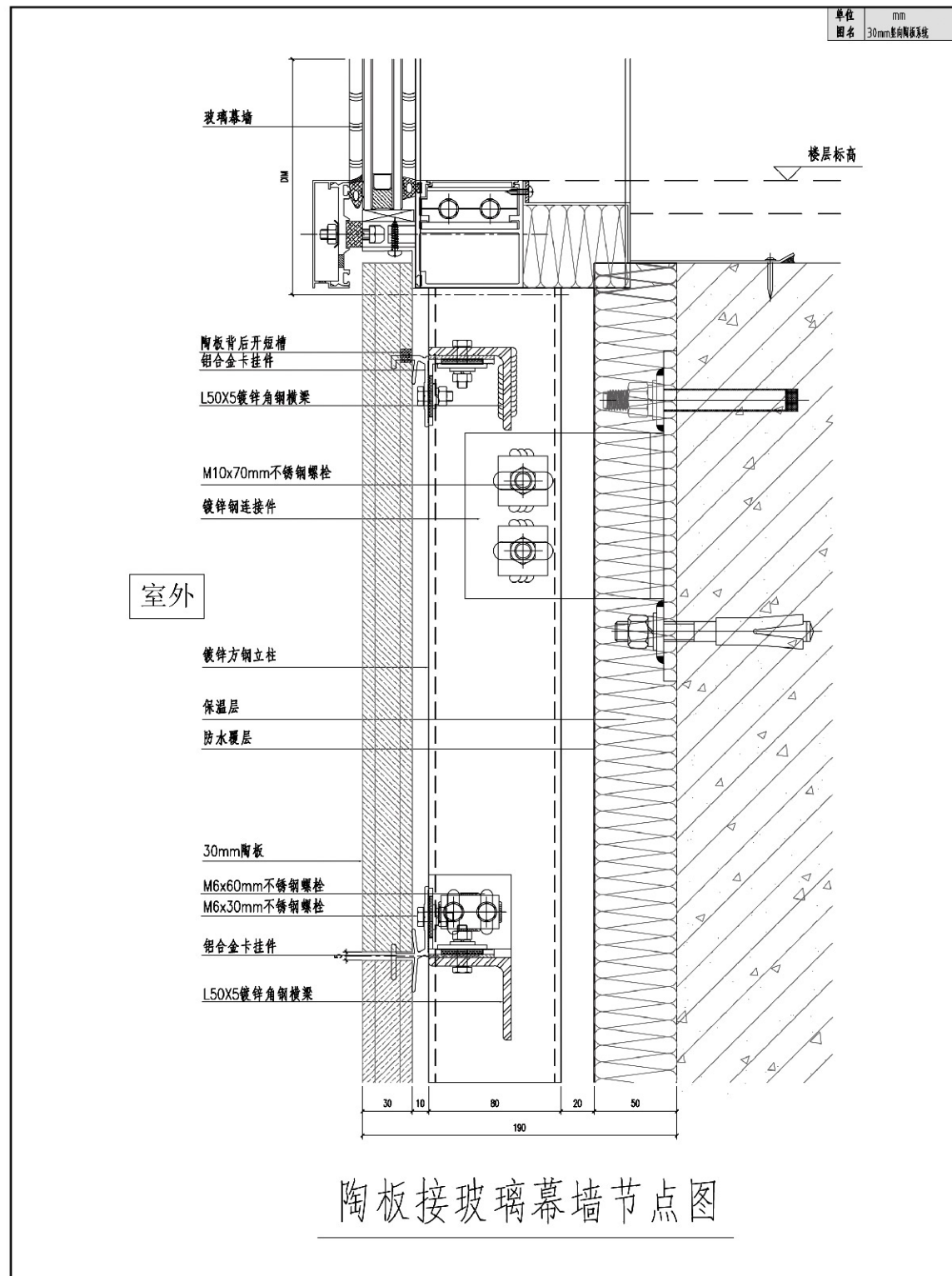

2. 30mm 竖向陶板系统 安装节点图

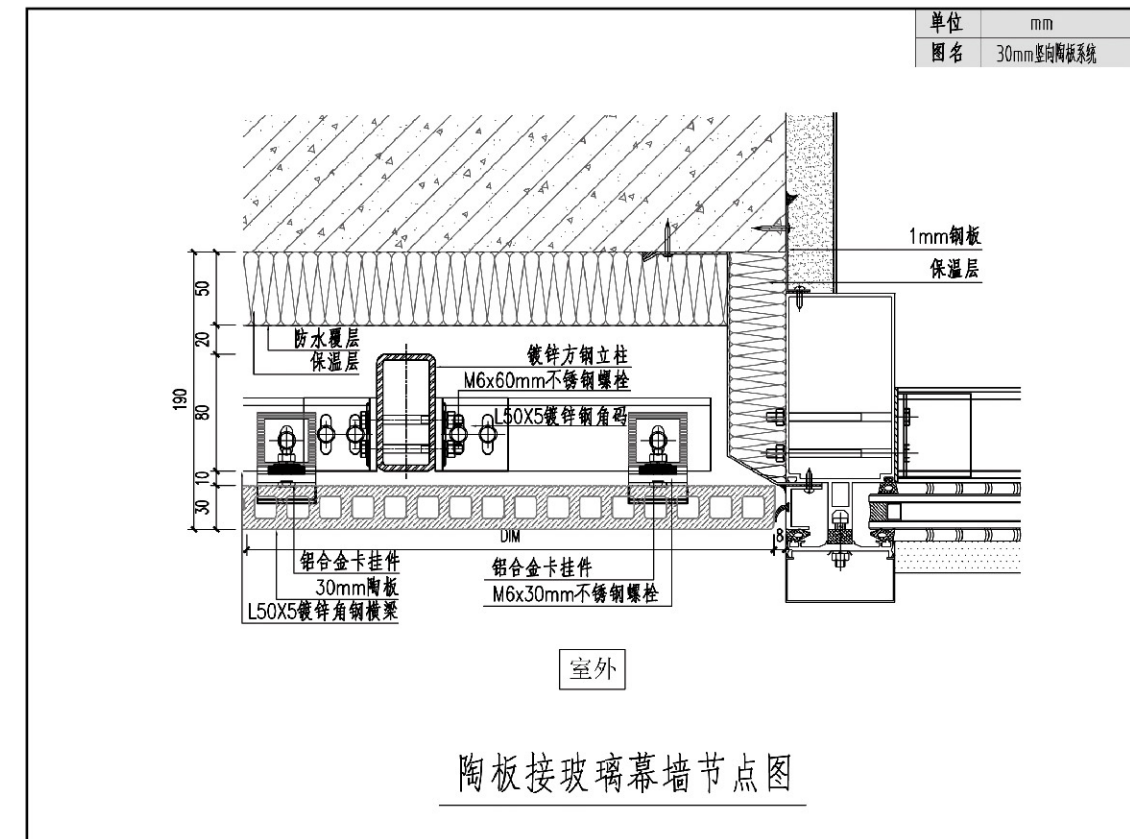

21mm
陶板系统
安装方案
21mm terracotta
panels mounting
system

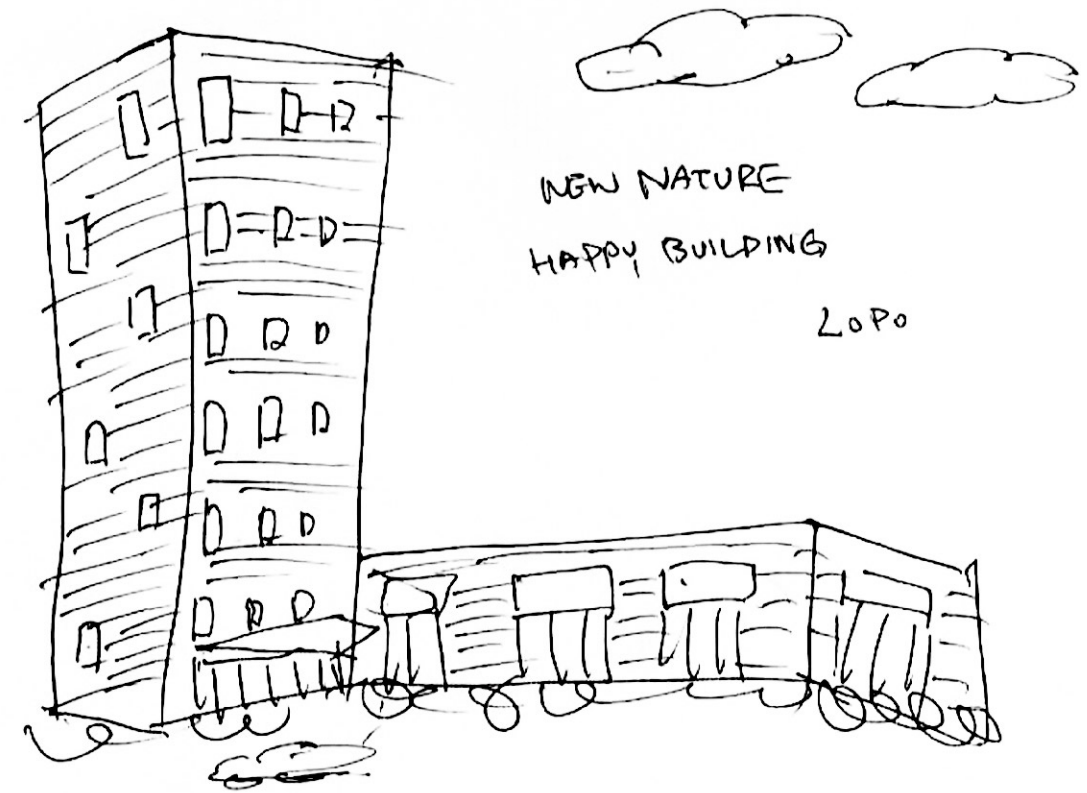
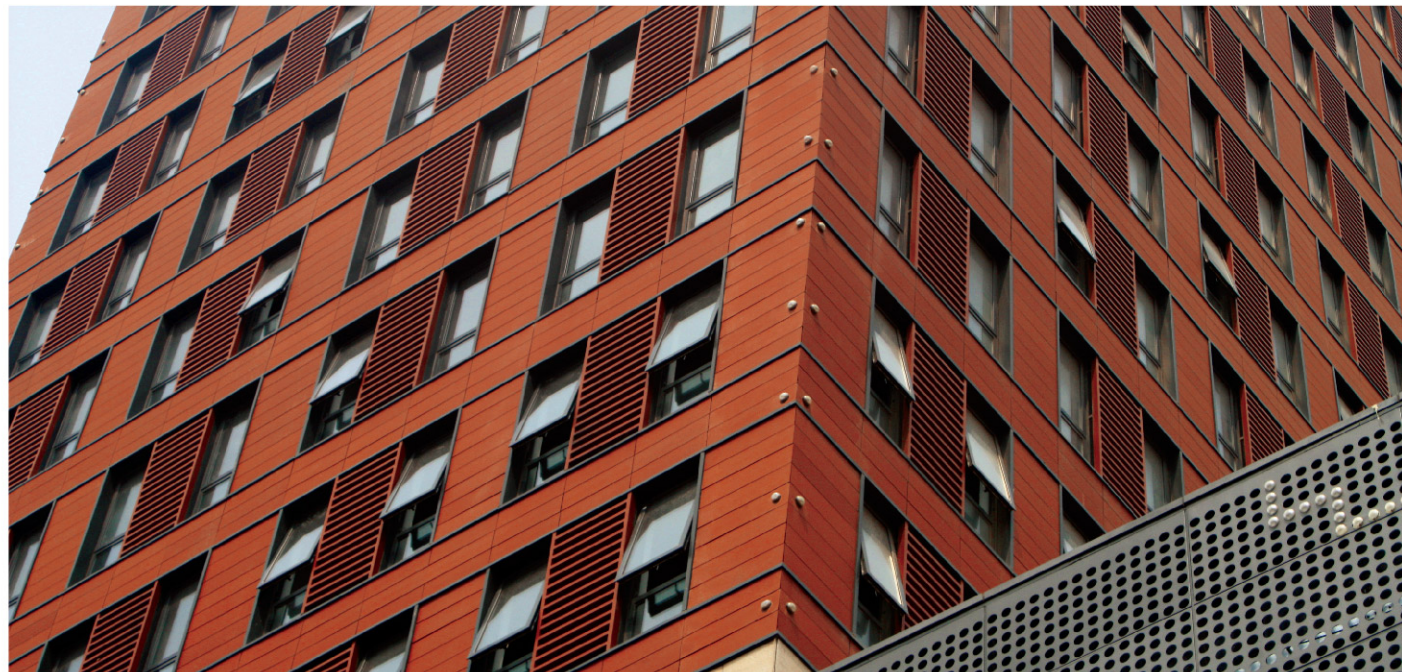

21mm
陶板系统
安装节点图

21mm
陶板系统
安装节点图

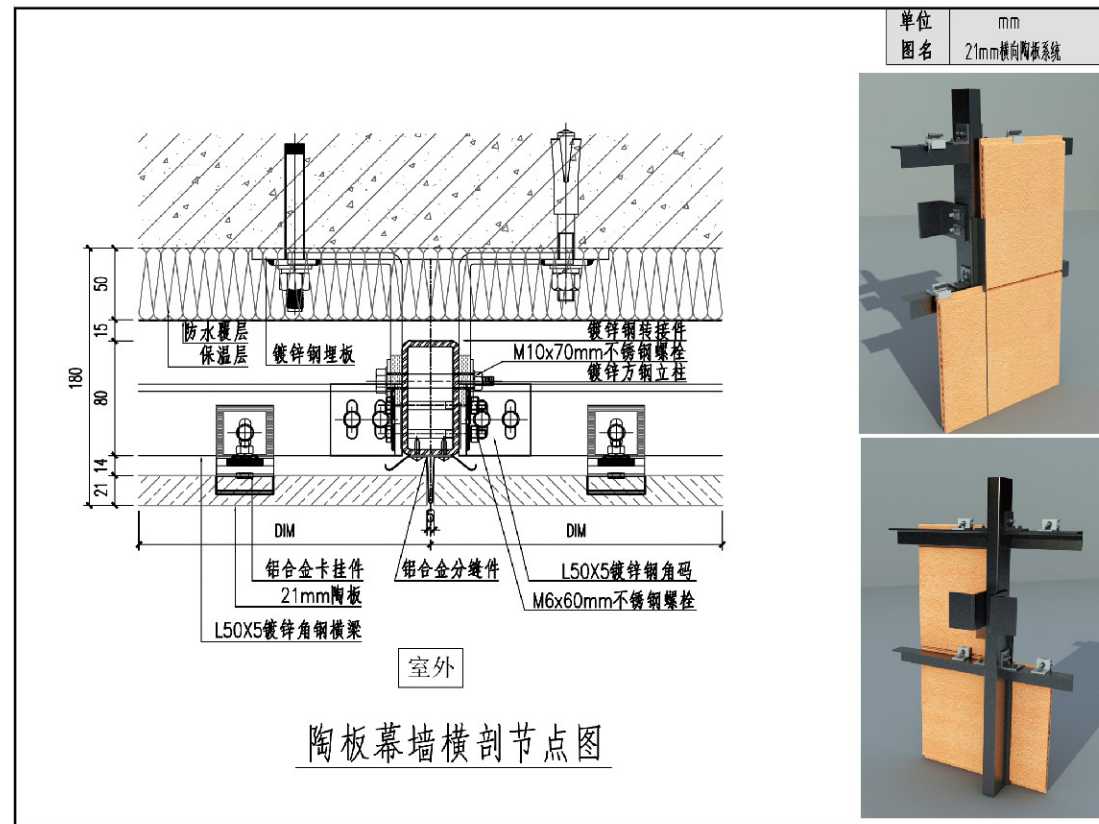

21mm
陶板系统
安装节点图

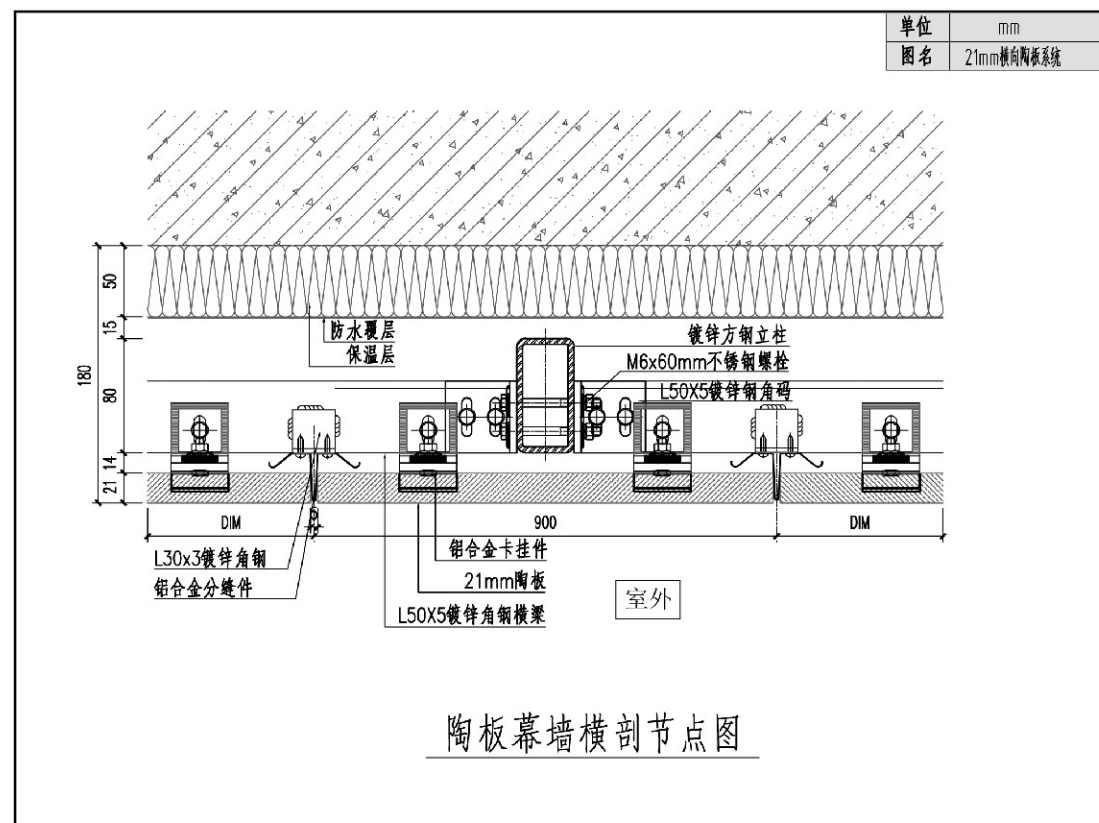
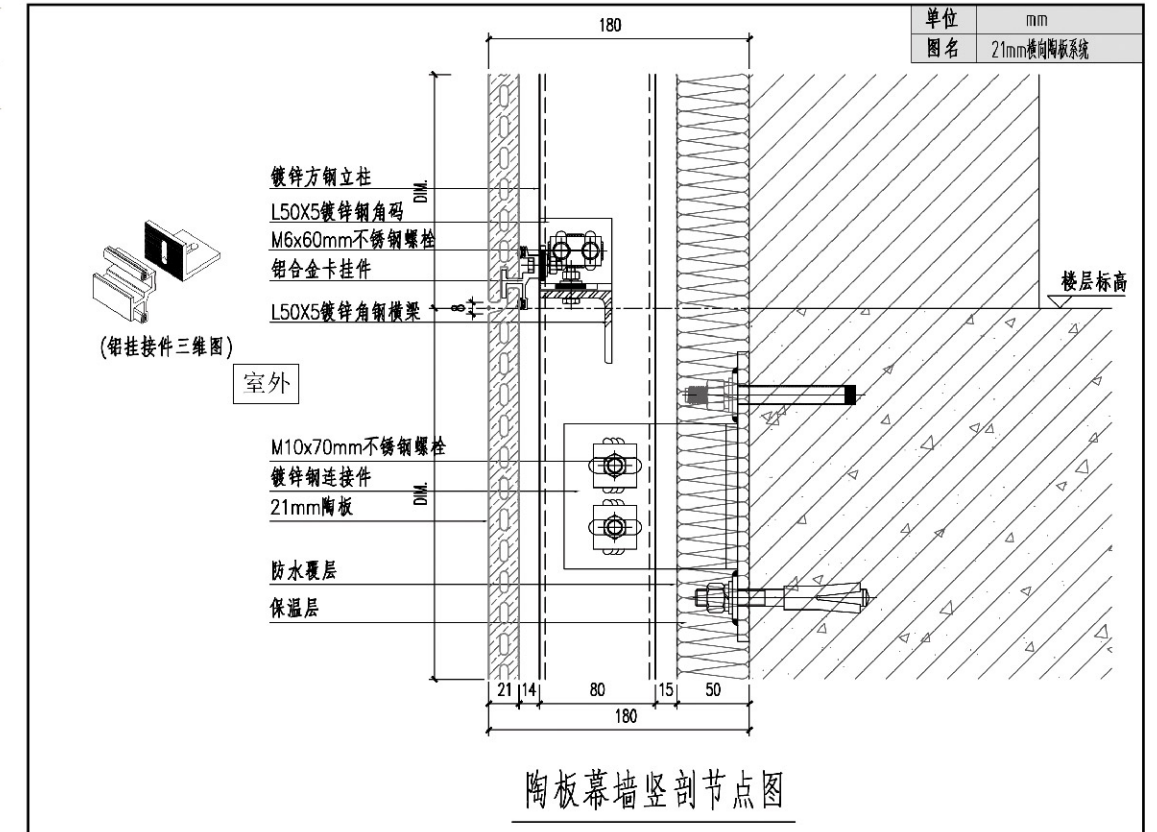

湿贴陶板
系统安装
方案
Terracotta tiles
system



WE ARE LIVING UNDER THIS WORLD
USING THE ENVIRONMENT, NOT CONQUERING
IT, DESTROYING IT, OR WE DESTROYED
LEONARD CHUEN

1.

9mm
湿贴陶板挂贴系
统安装节点图

1.

9mm
湿贴陶板挂贴系统
安装节点图

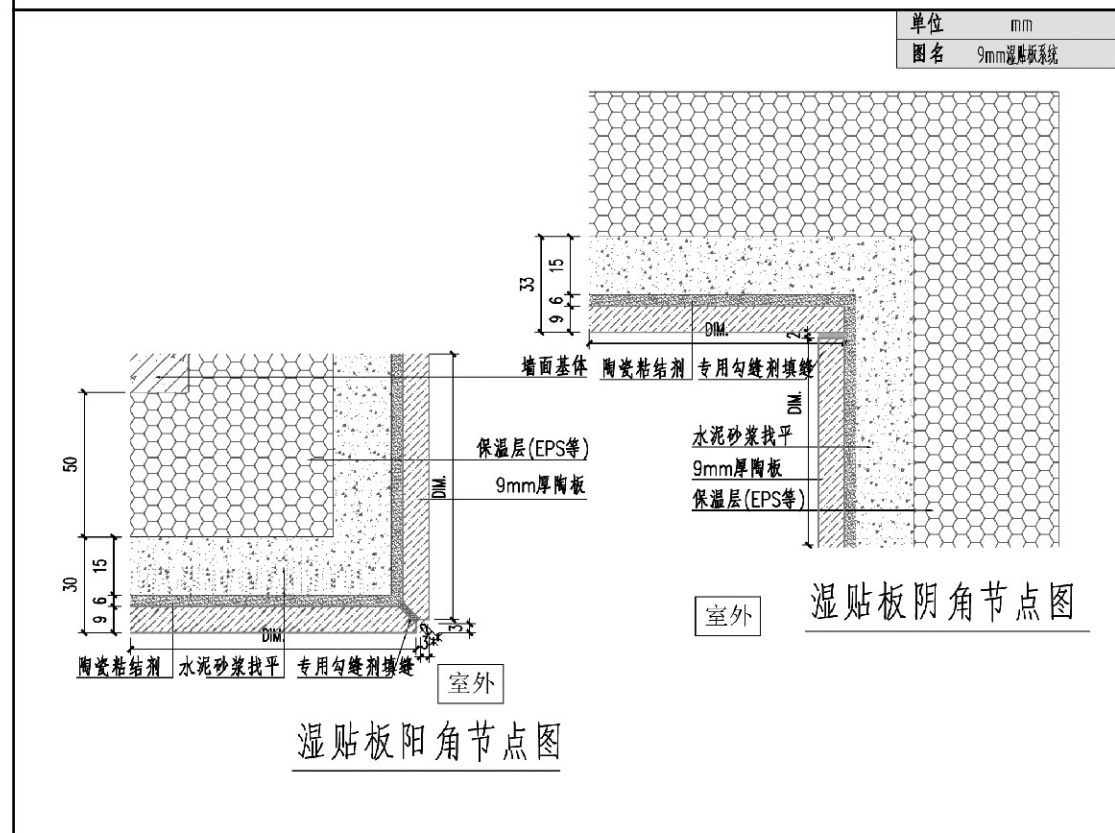
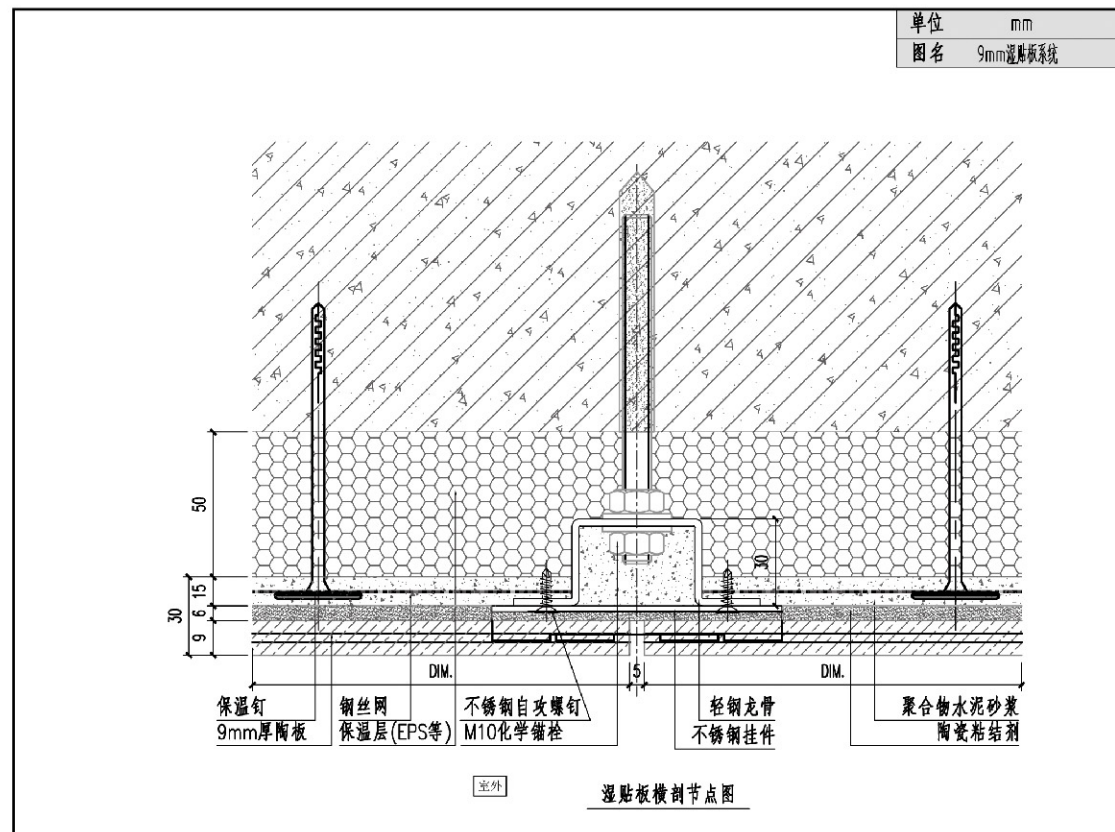

1.

9mm
湿贴陶板挂贴系统
安装节点图

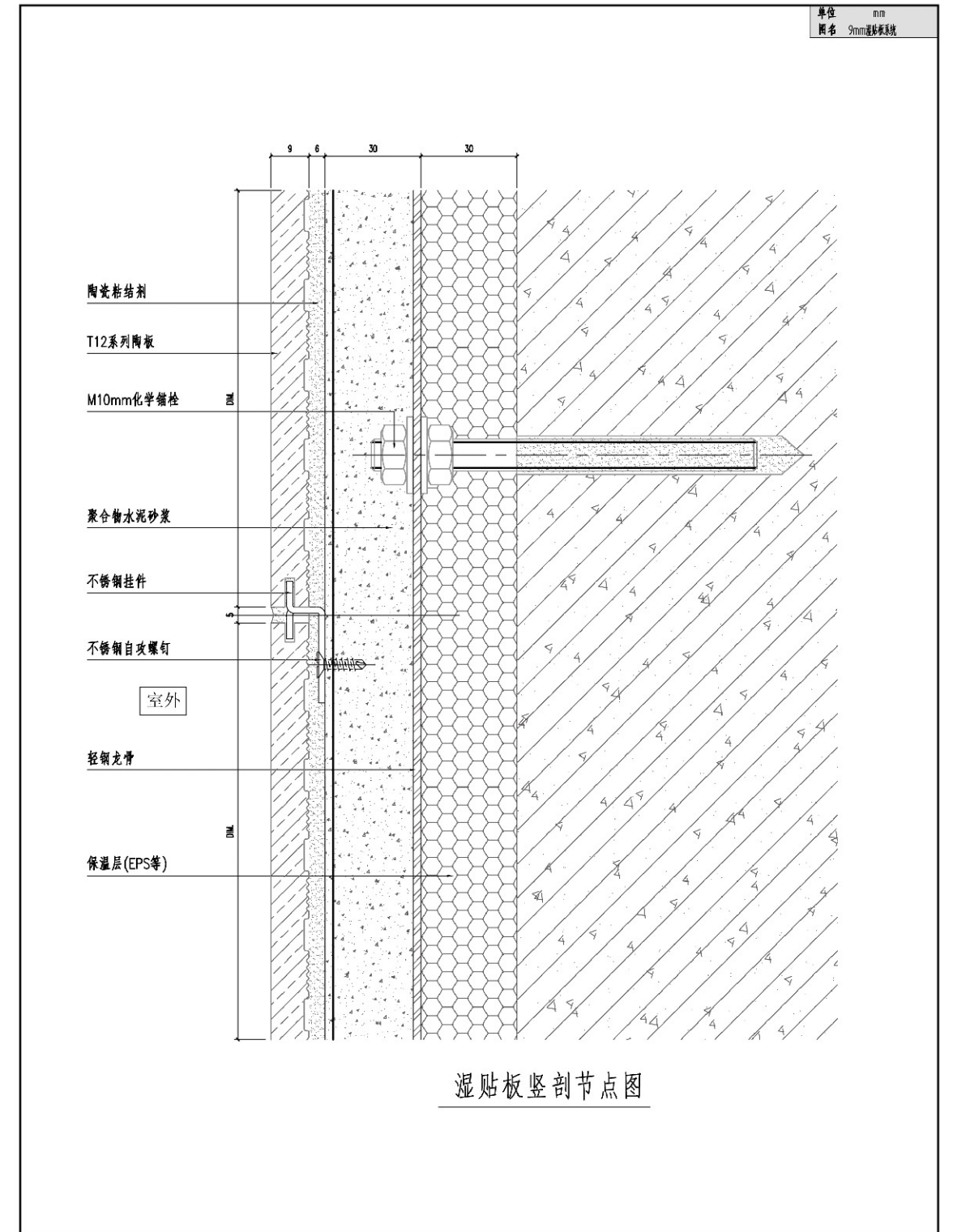

1.

9mm
湿贴陶板挂贴系统
安装节点图

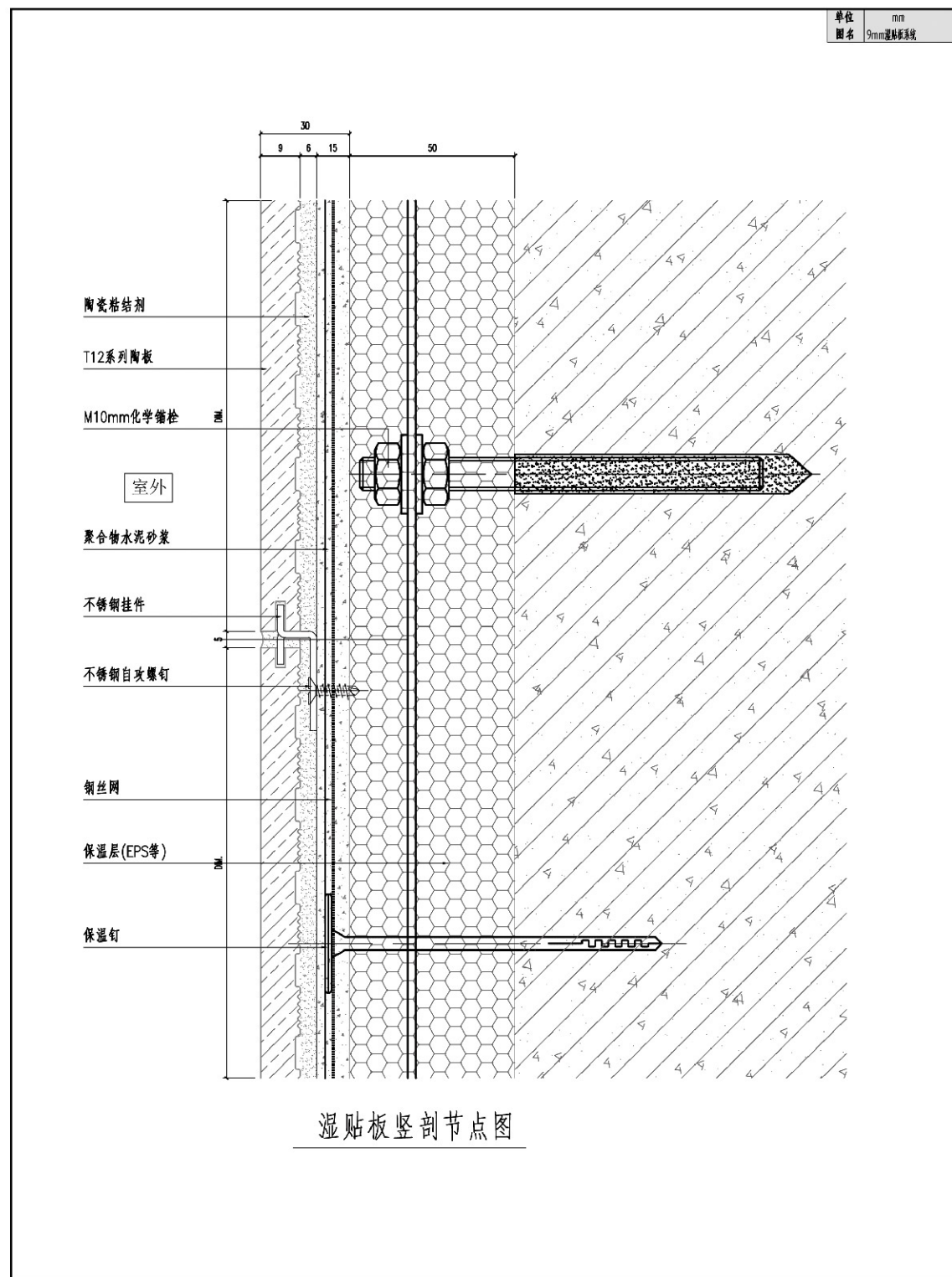

1.

9mm
湿贴陶板挂贴系统
安装节点图

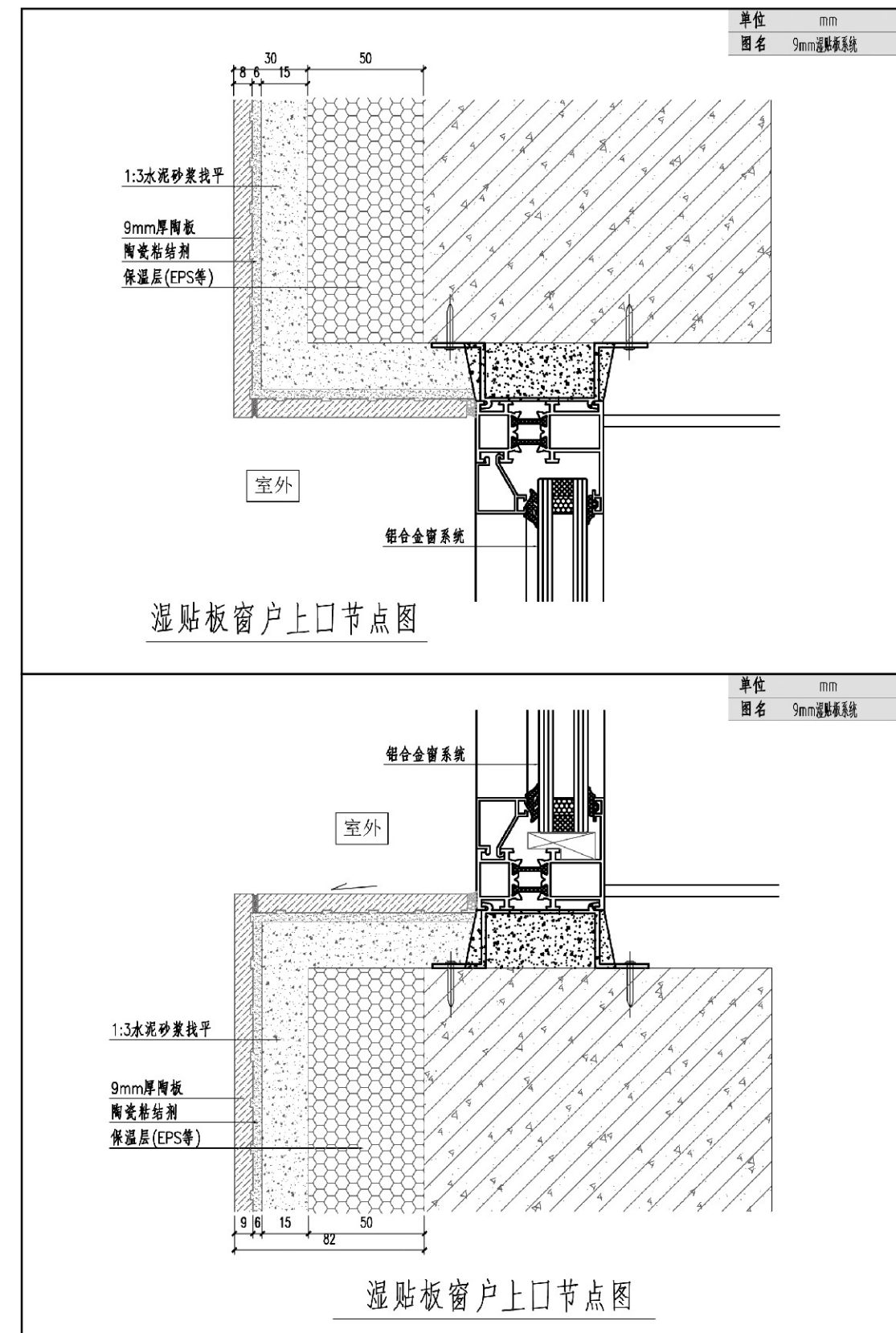

1.

9mm 湿贴陶板挂贴系统 安装节点图

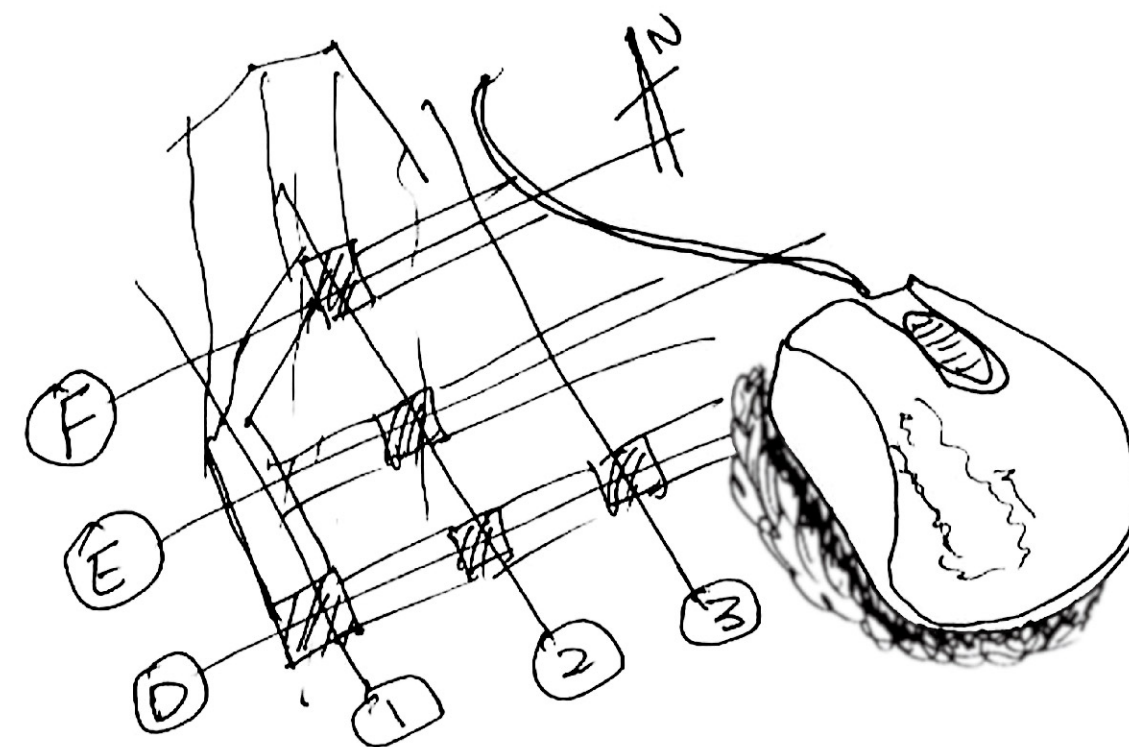
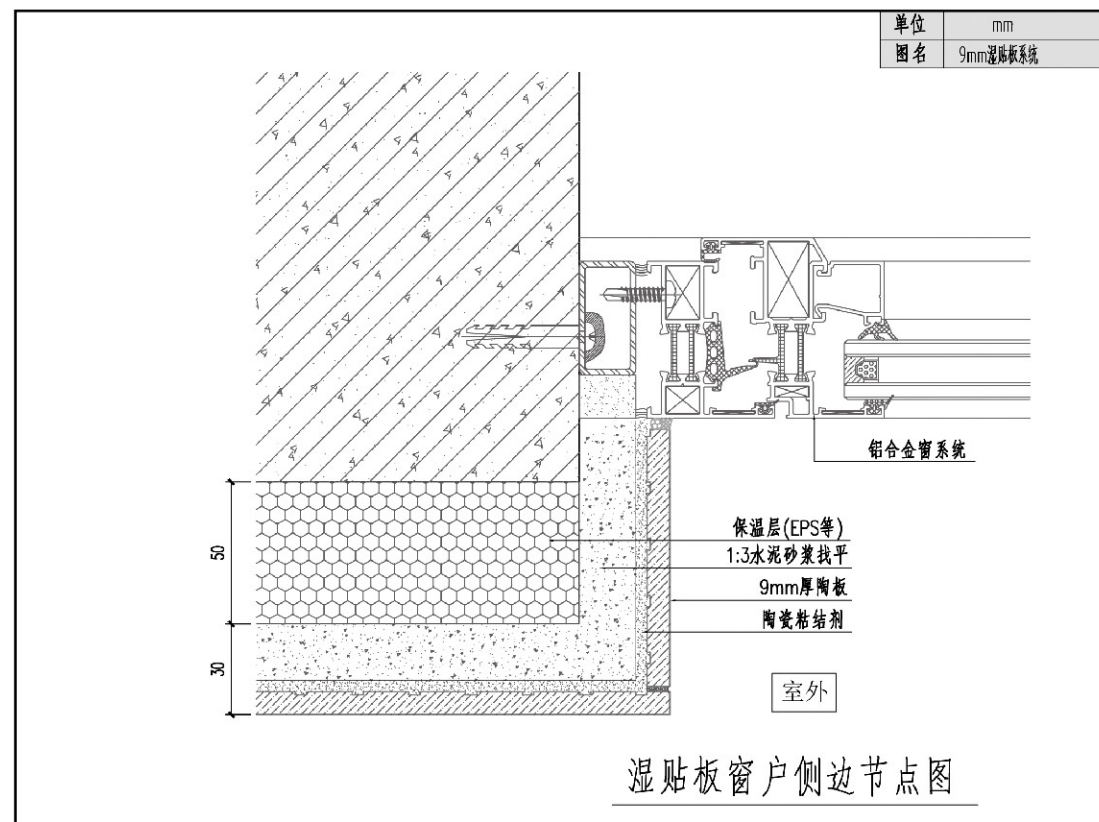

2.

11mm 湿贴陶板挂贴系 统安装节点图

2.

11mm
湿贴陶板挂贴系统
安装节点图

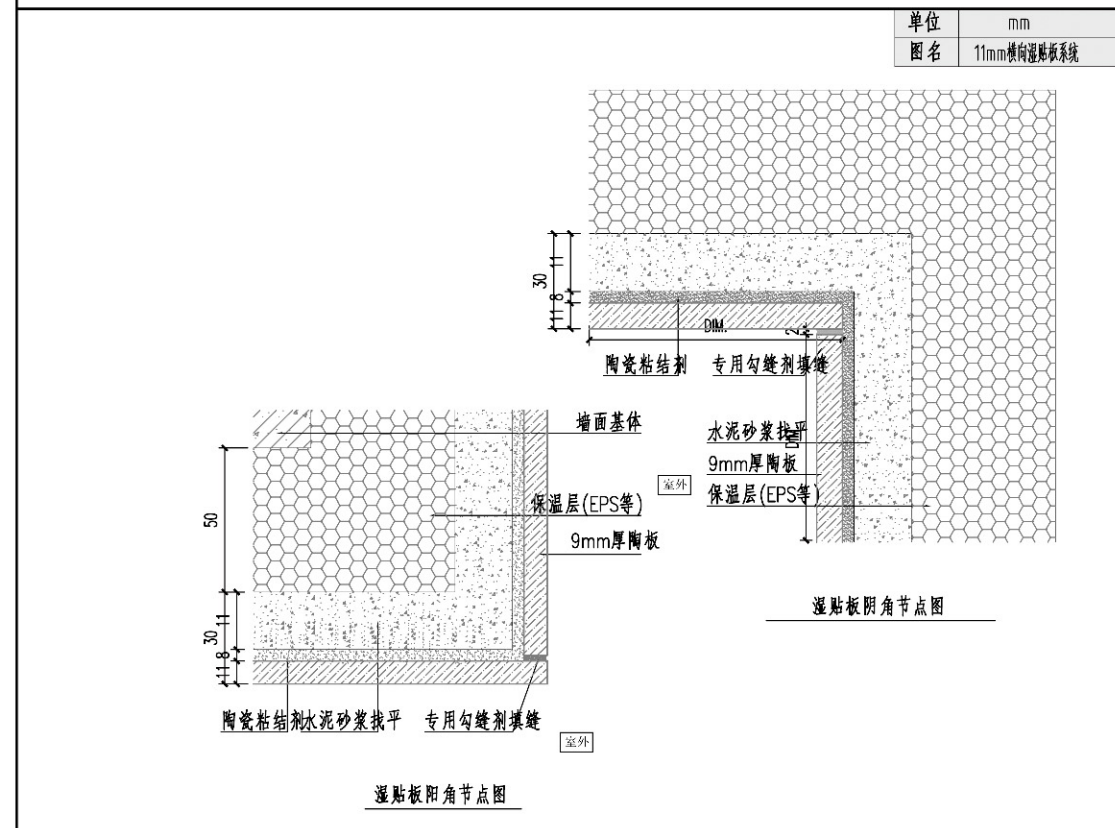
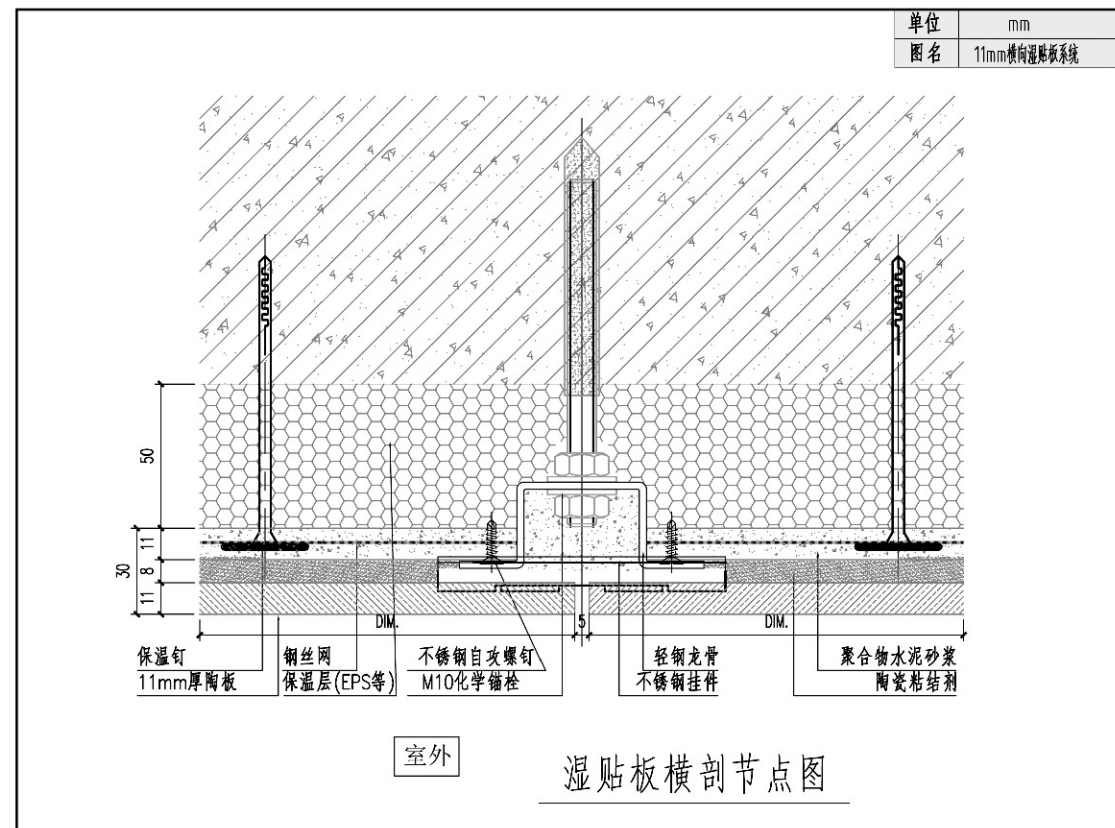

2.

11mm
湿贴陶板挂贴系统
安装节点图

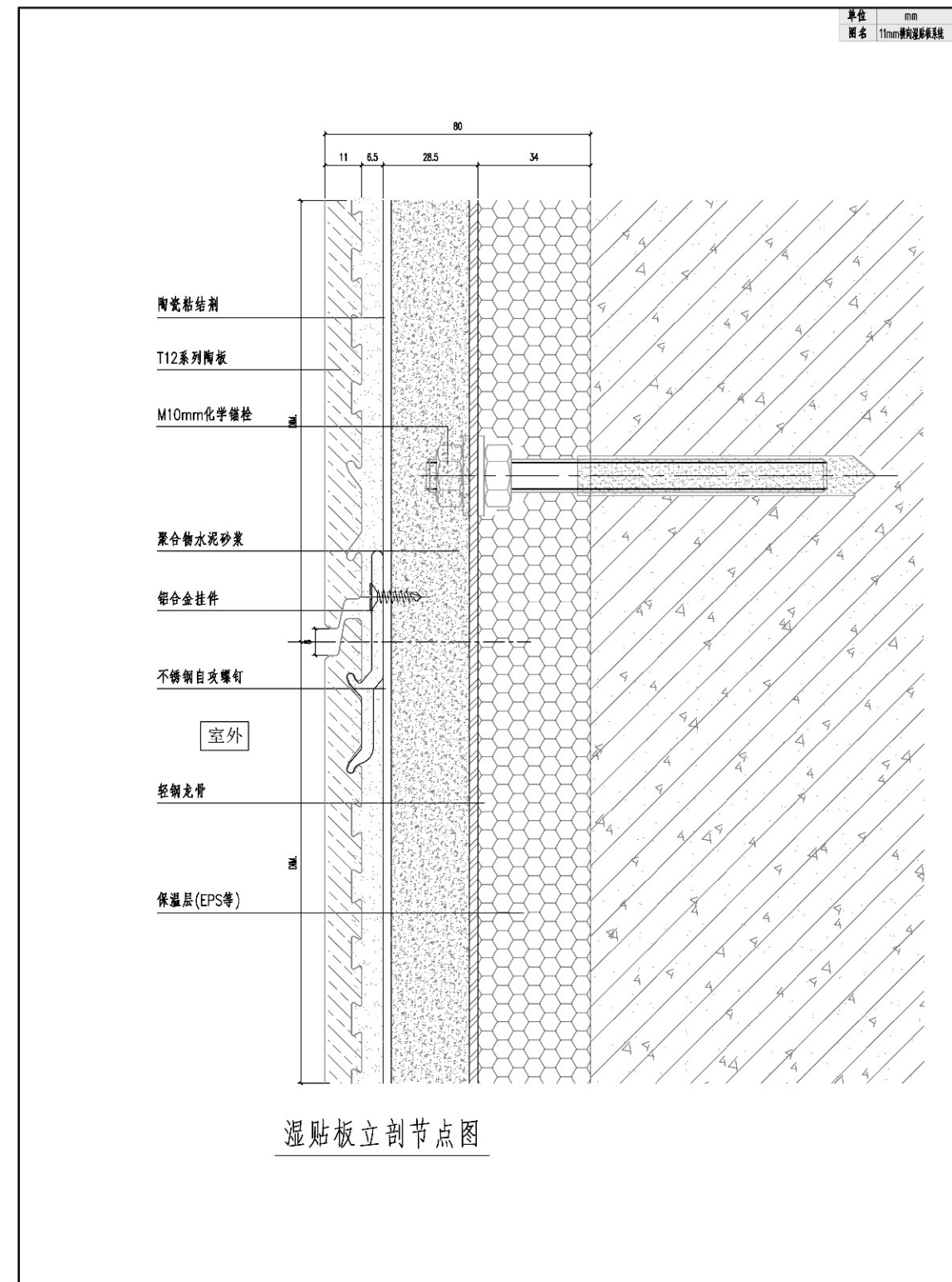

2.

11mm
湿贴陶板挂贴系统
安装节点图

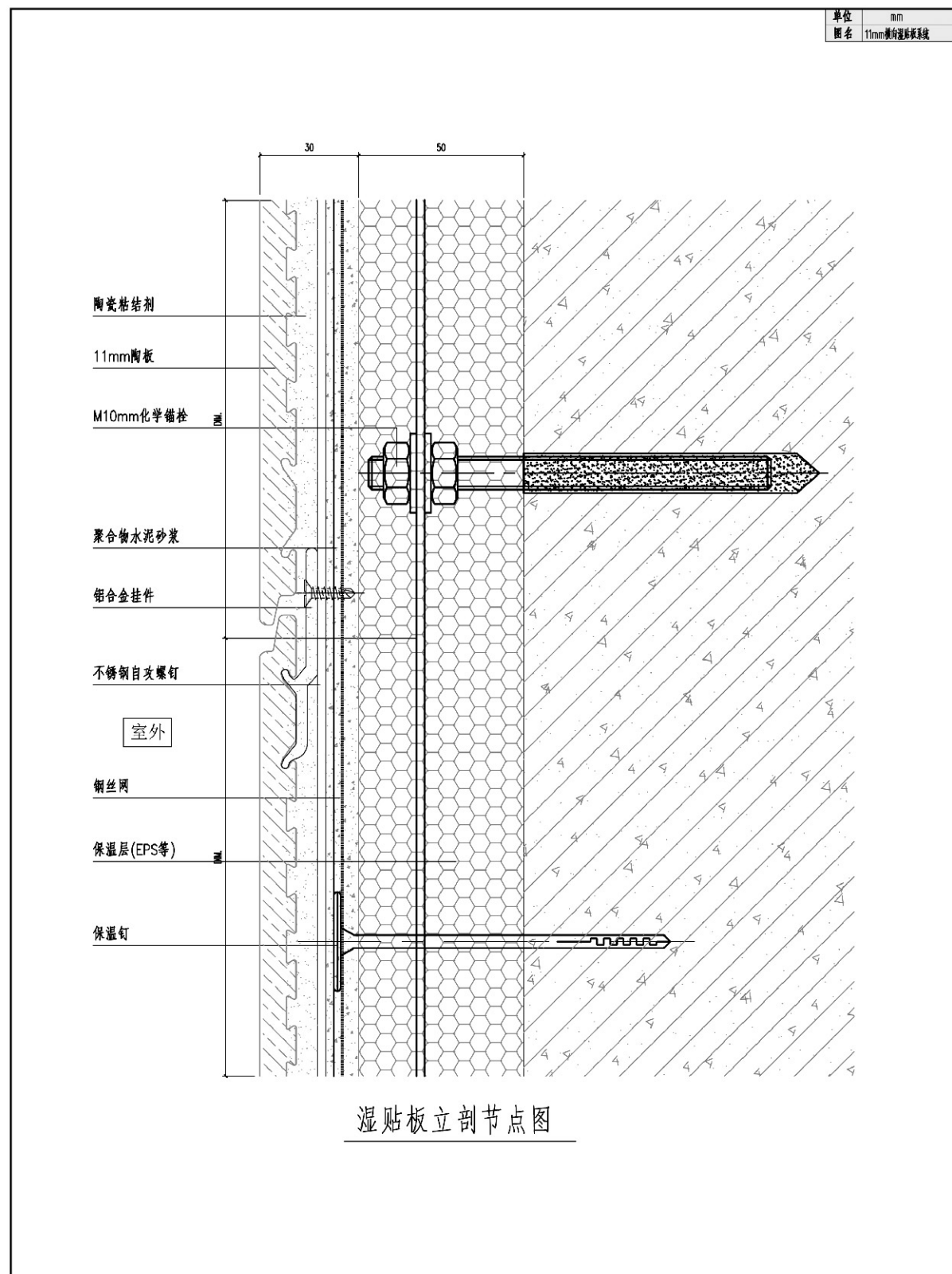

2.

11mm
湿贴陶板挂贴系统
安装节点图

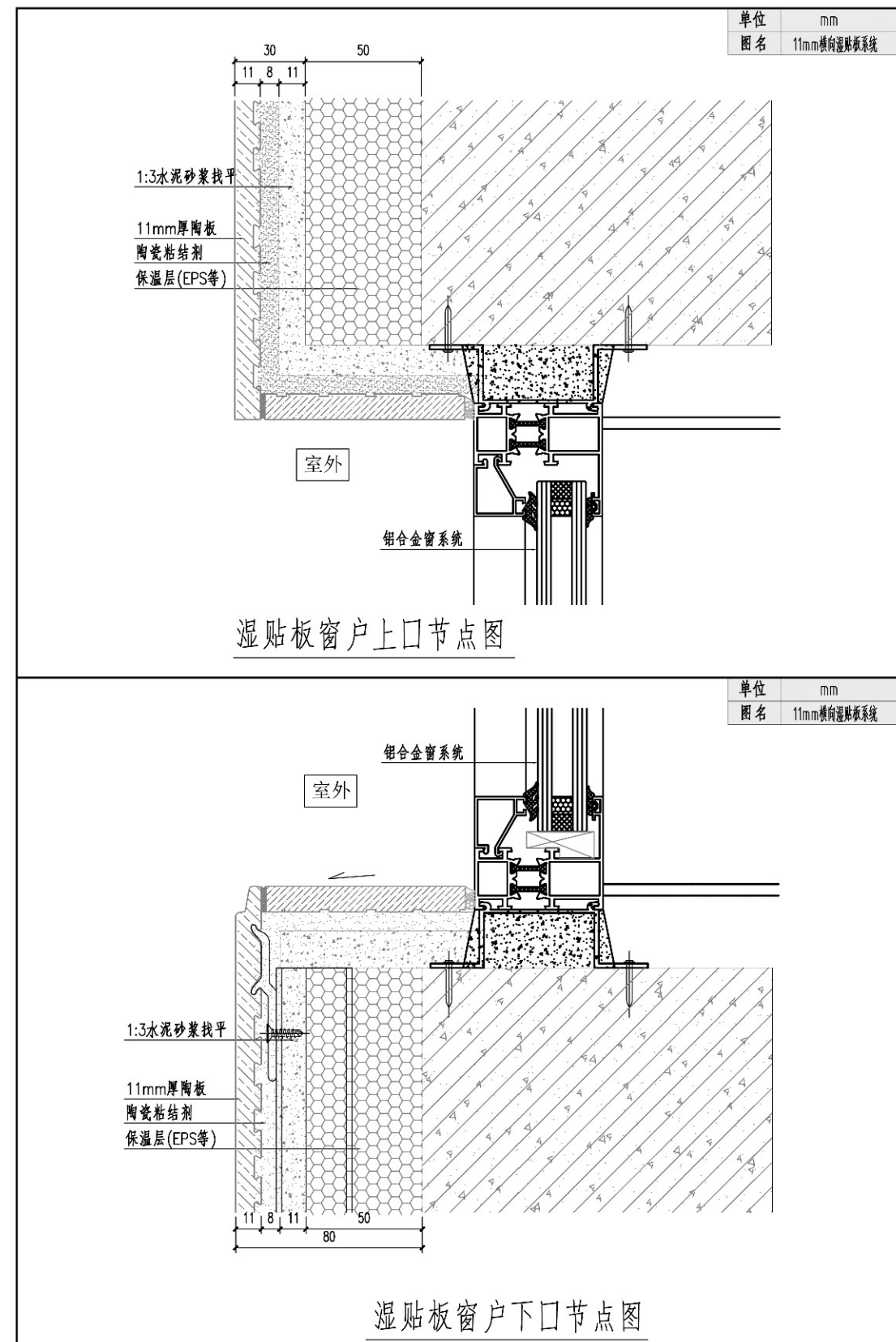

2.

11mm
湿贴陶板挂贴系统
安装节点图

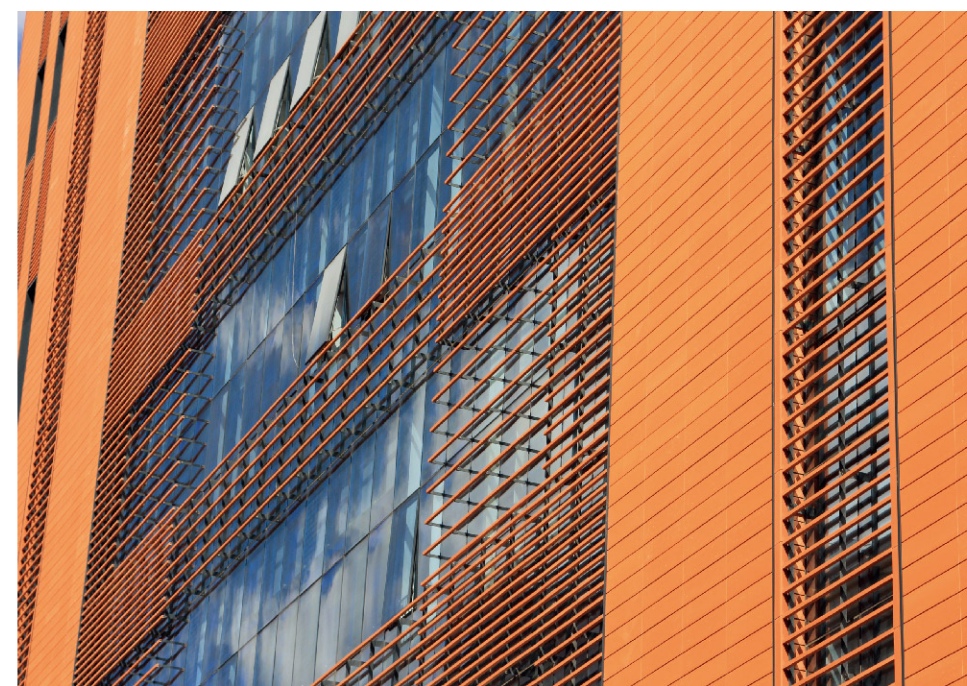
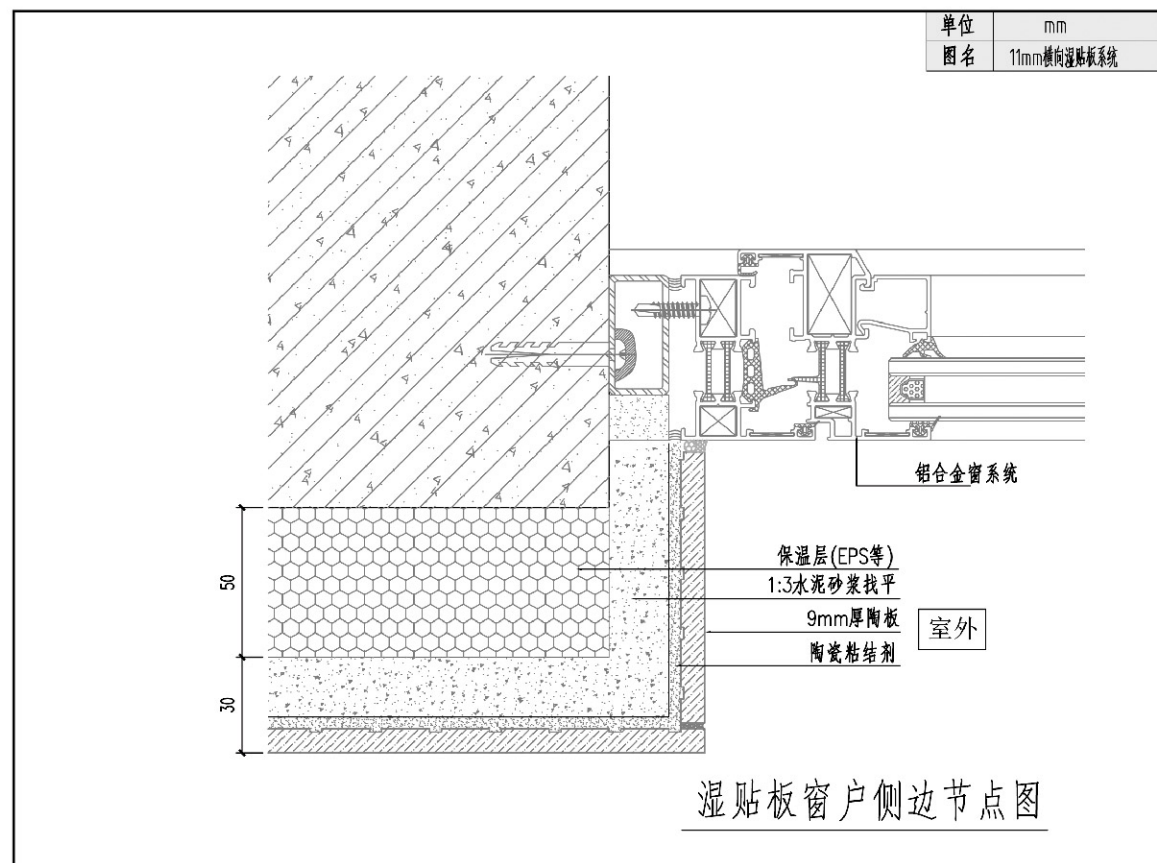

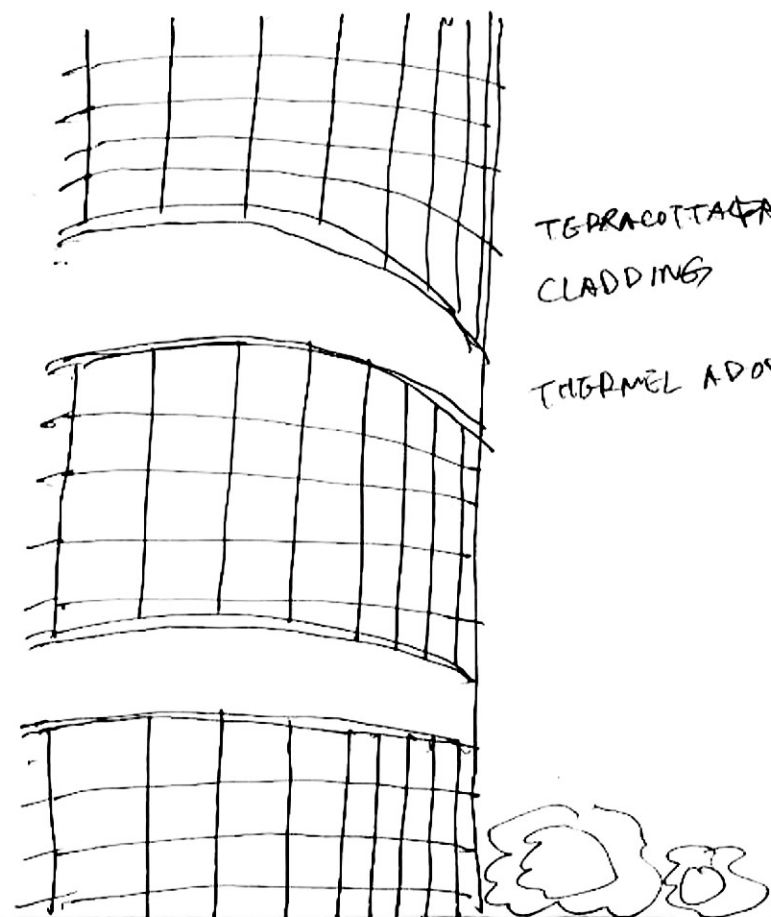

TERRACOTTA FRENEL
CLADDING

THERMEL ADOPTED.

1.

50X50
陶管系统
安装节点图

1.

50x50
陶管系统(1)
安装节点图

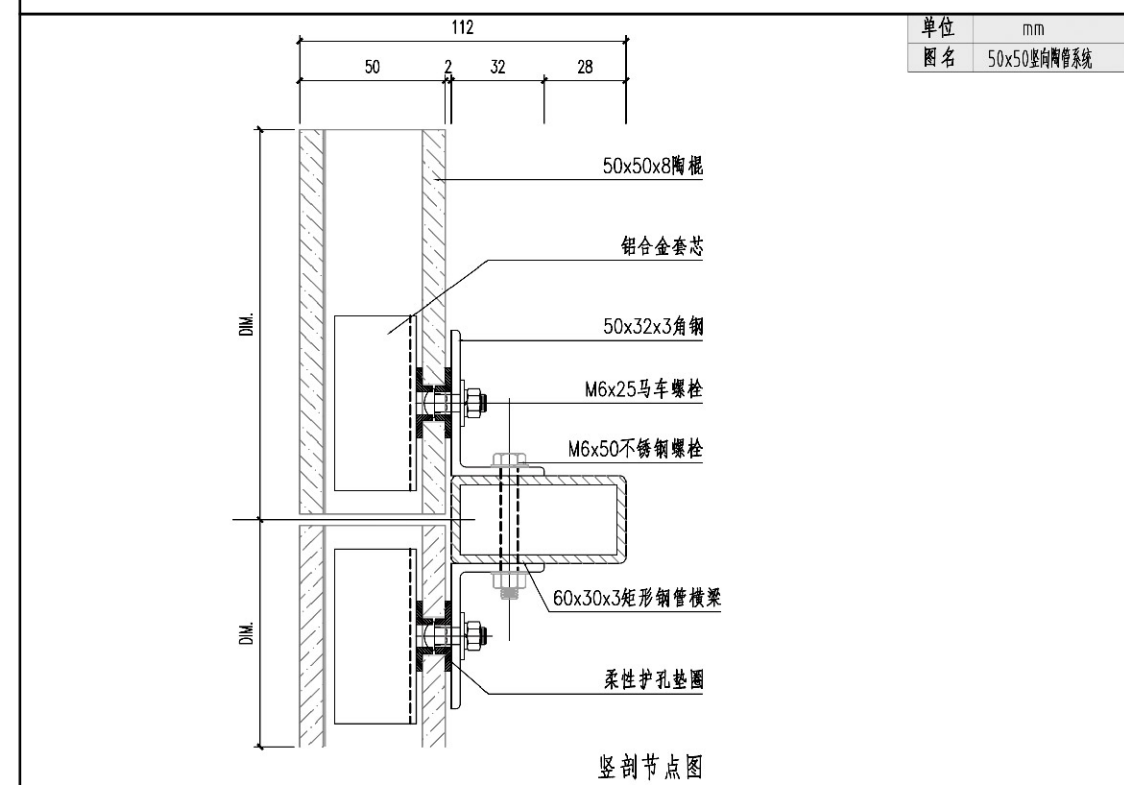
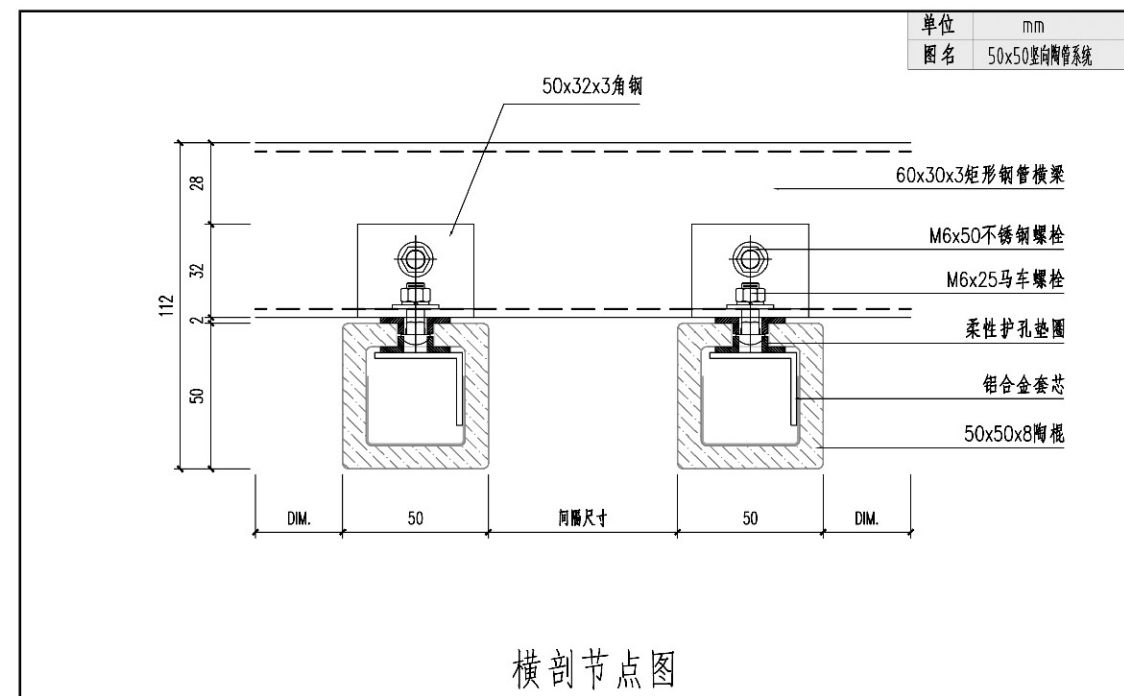

1.

50x50
陶管系统(2)
安装节点图

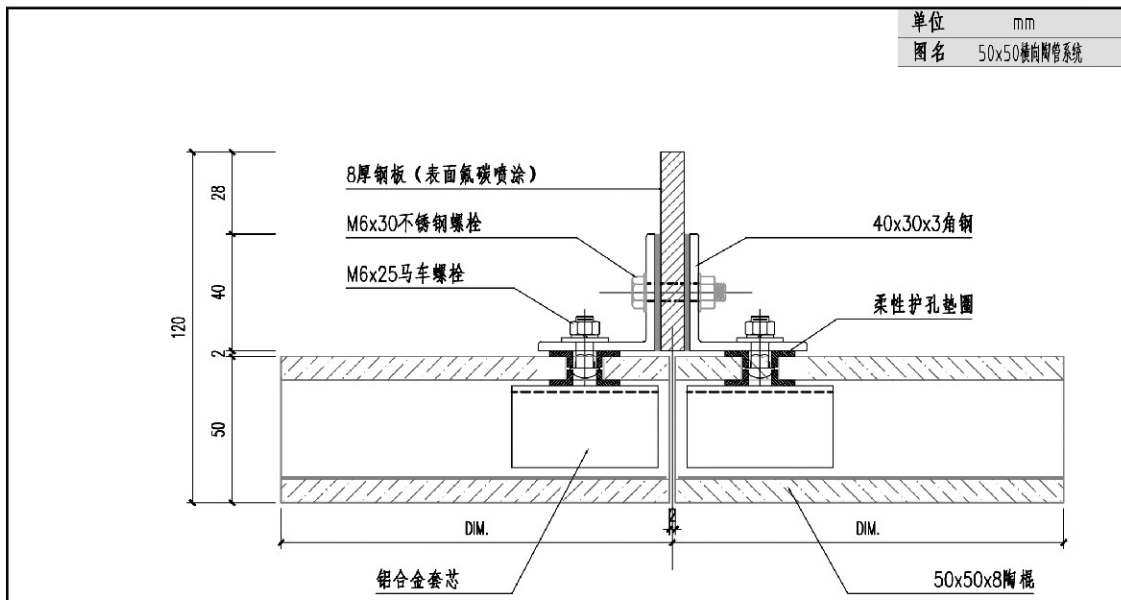

单位 mm
图名 50x50横向陶管系统

横剖节点图

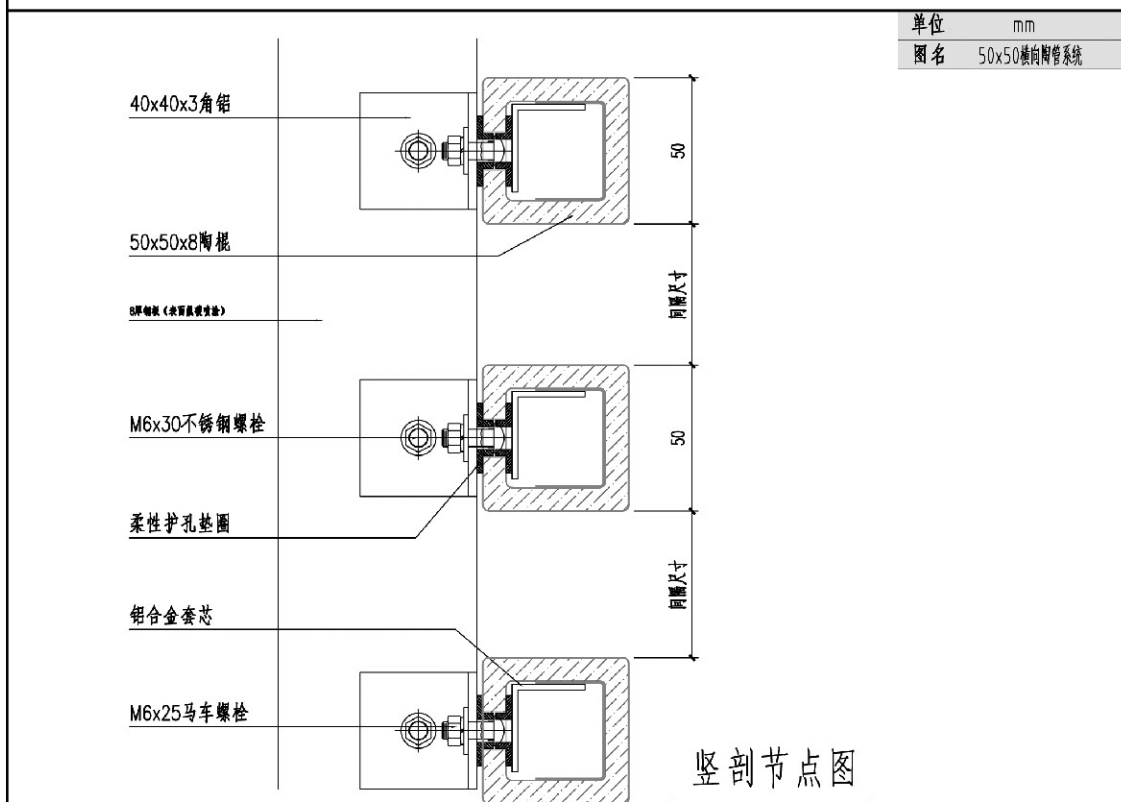

单位 mm
图名 50x50横向陶管系统

竖剖节点图

1.

50x50
陶管系统(2)
安装节点图

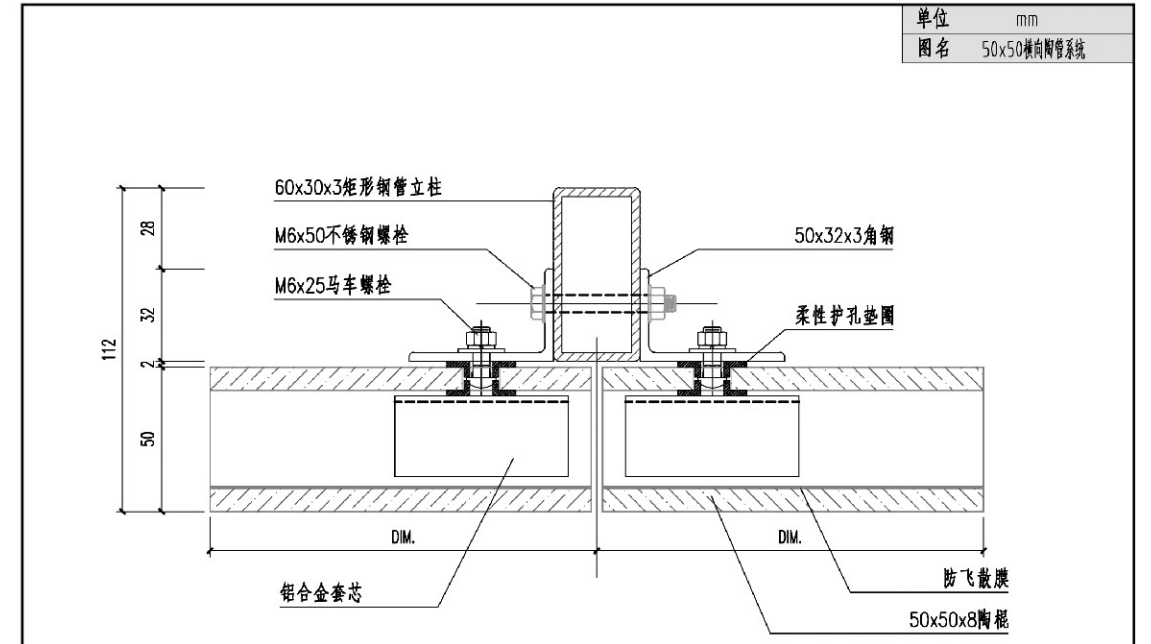

单位 mm
图名 50x50横向陶管系统

横剖节点图

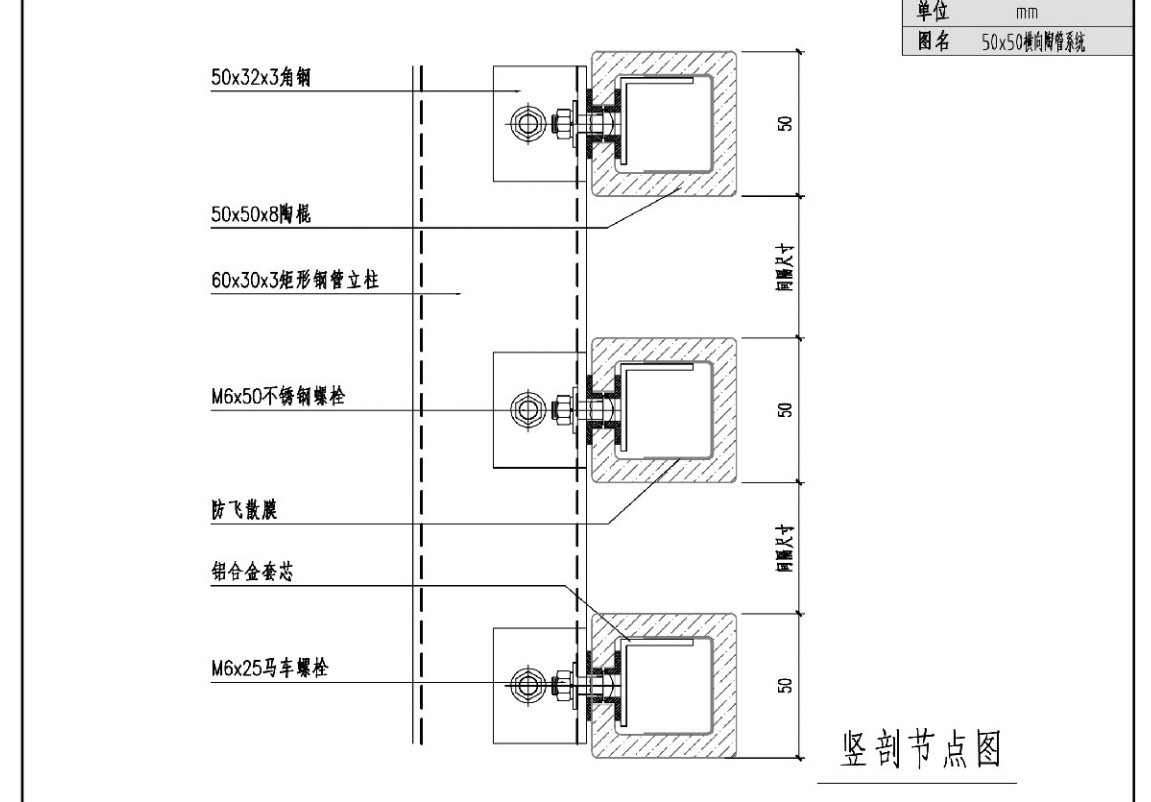

单位 mm
图名 50x50横向陶管系统

竖剖节点图

1.
50x50
陶管系统(3)
安装节点图

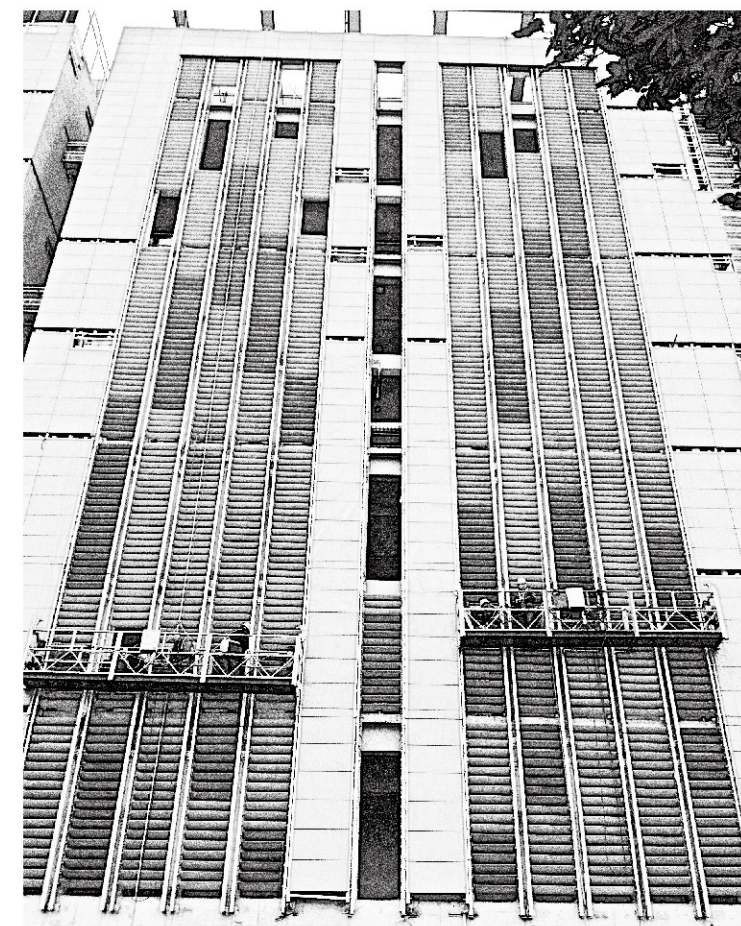
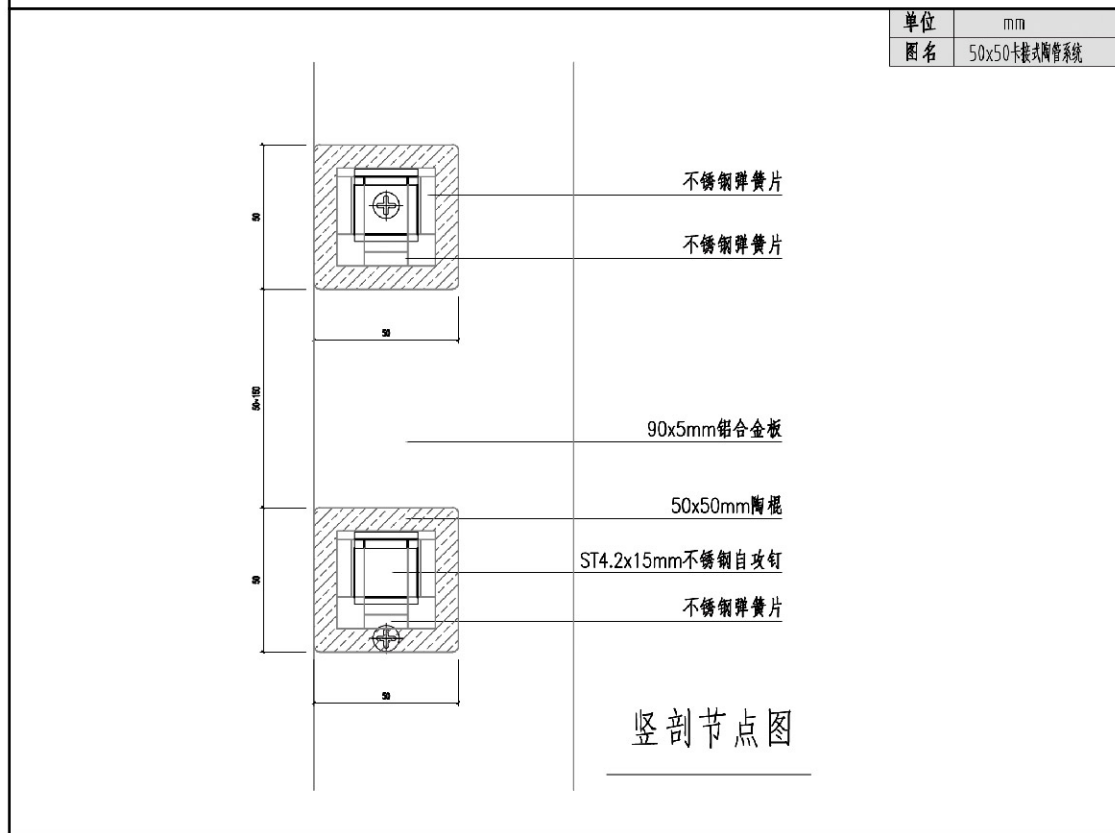
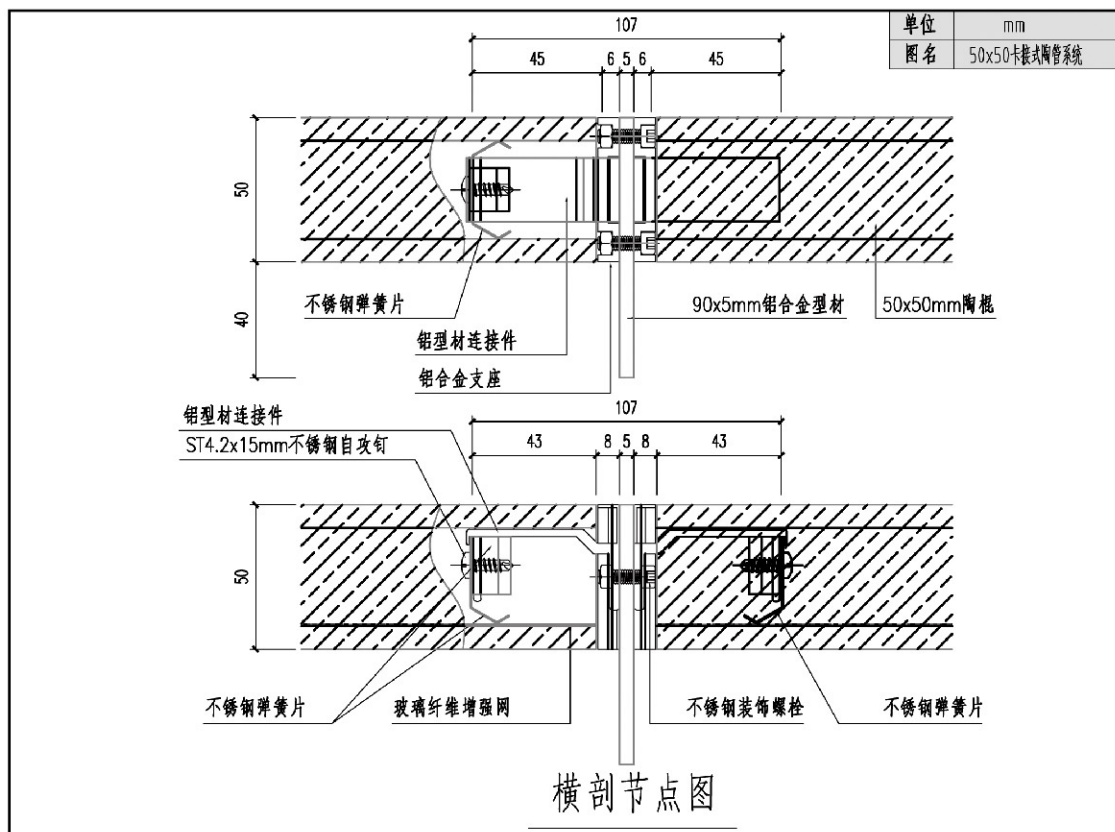

2.

38X80
陶管系统
安装节点图

2. 38x80 陶管系统 安装节点图

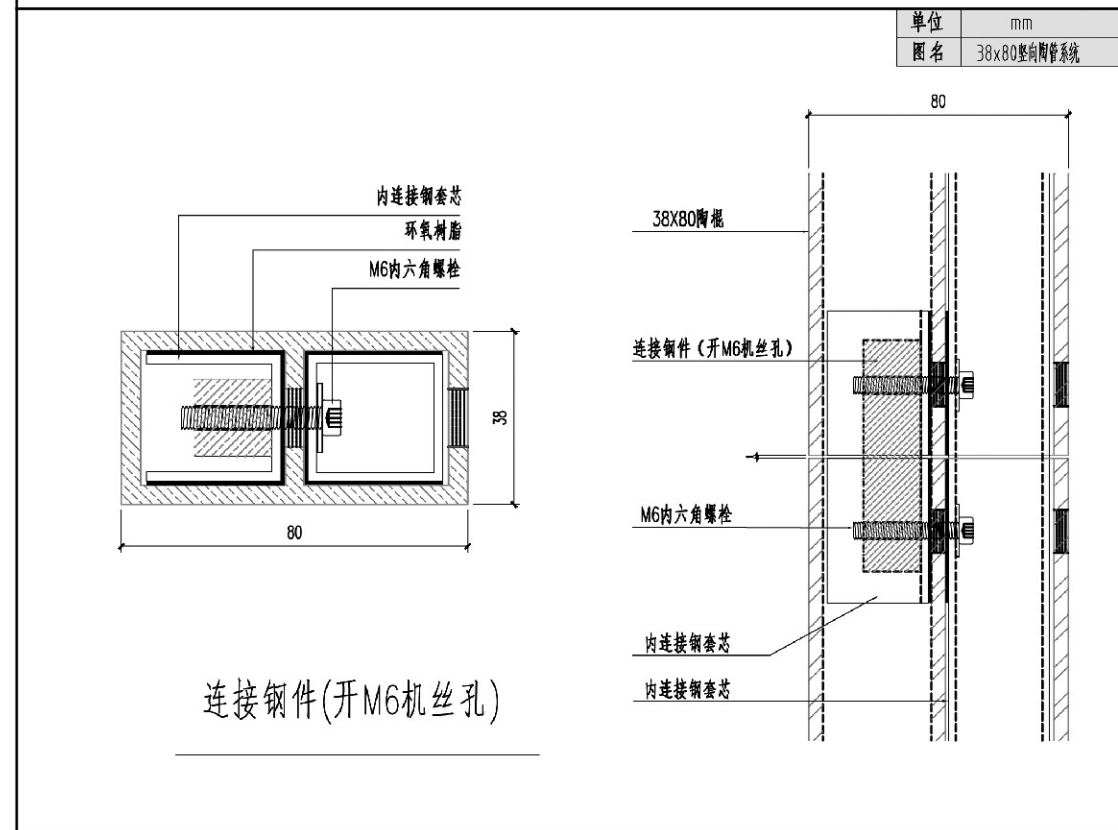
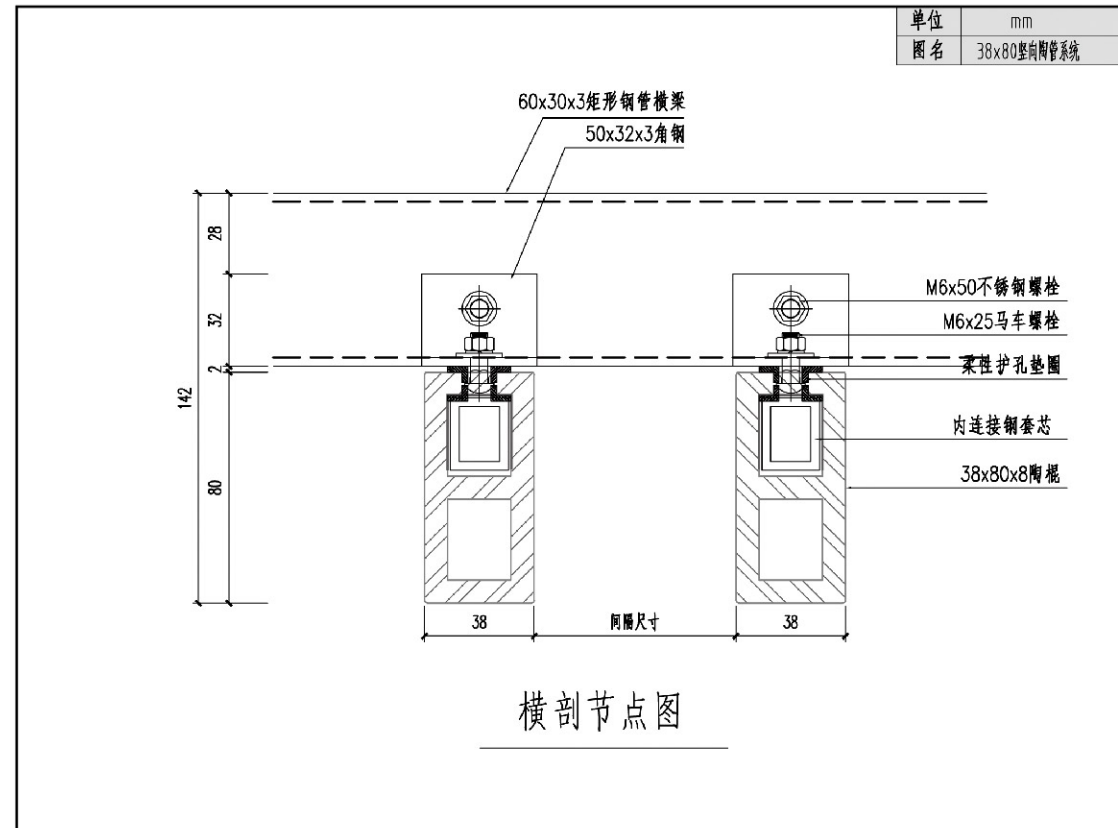

2. 38x80 陶管系统 安装节点图

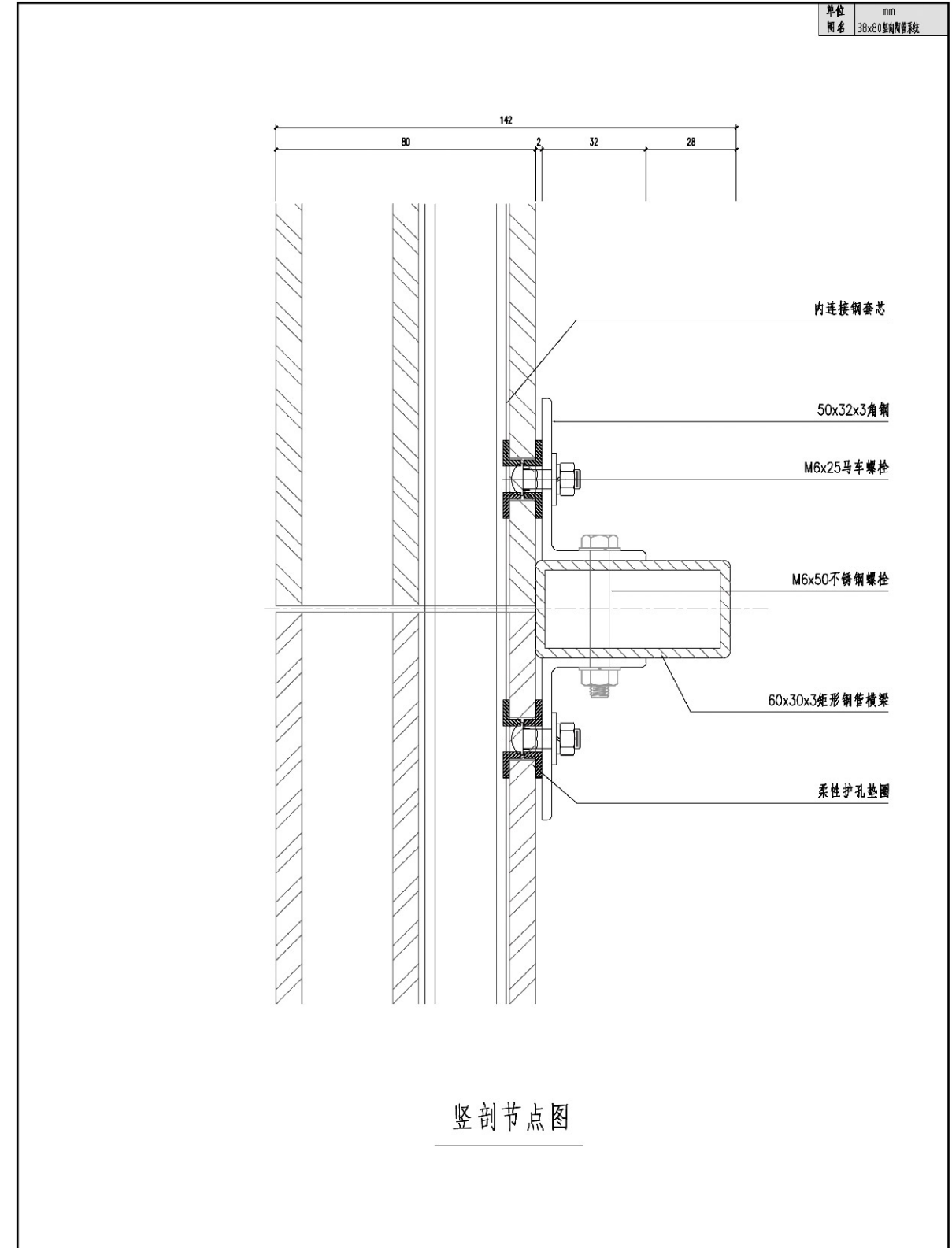



3.
40X85
陶管系统
安装节点图

3.
40x85
陶管系统
安装节点图

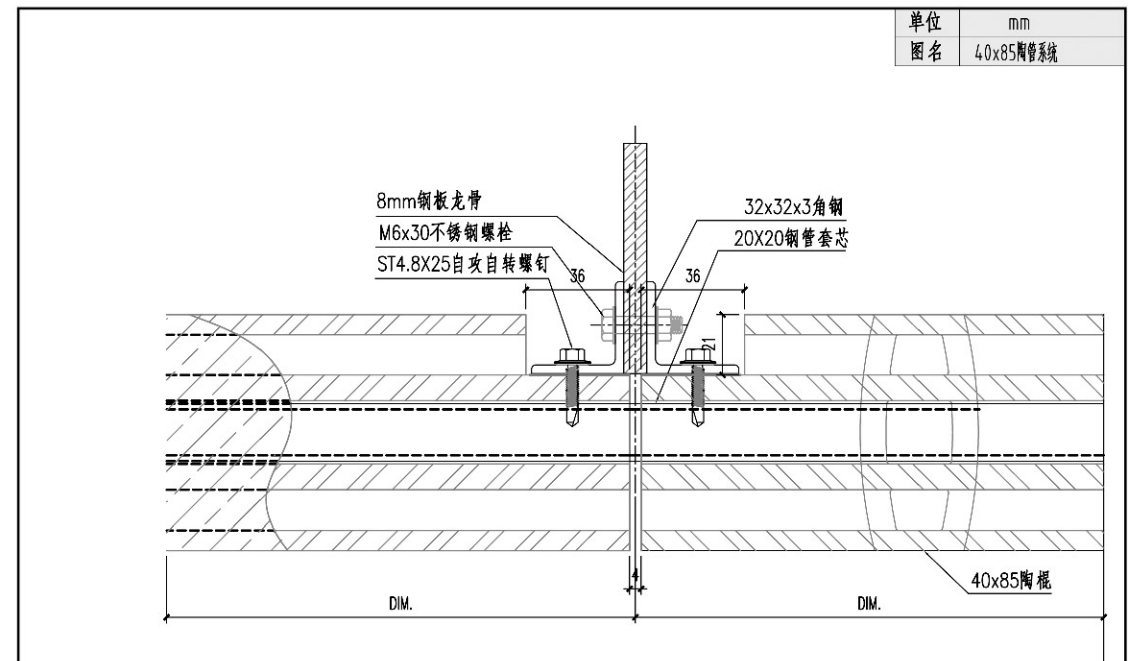

横剖节点图

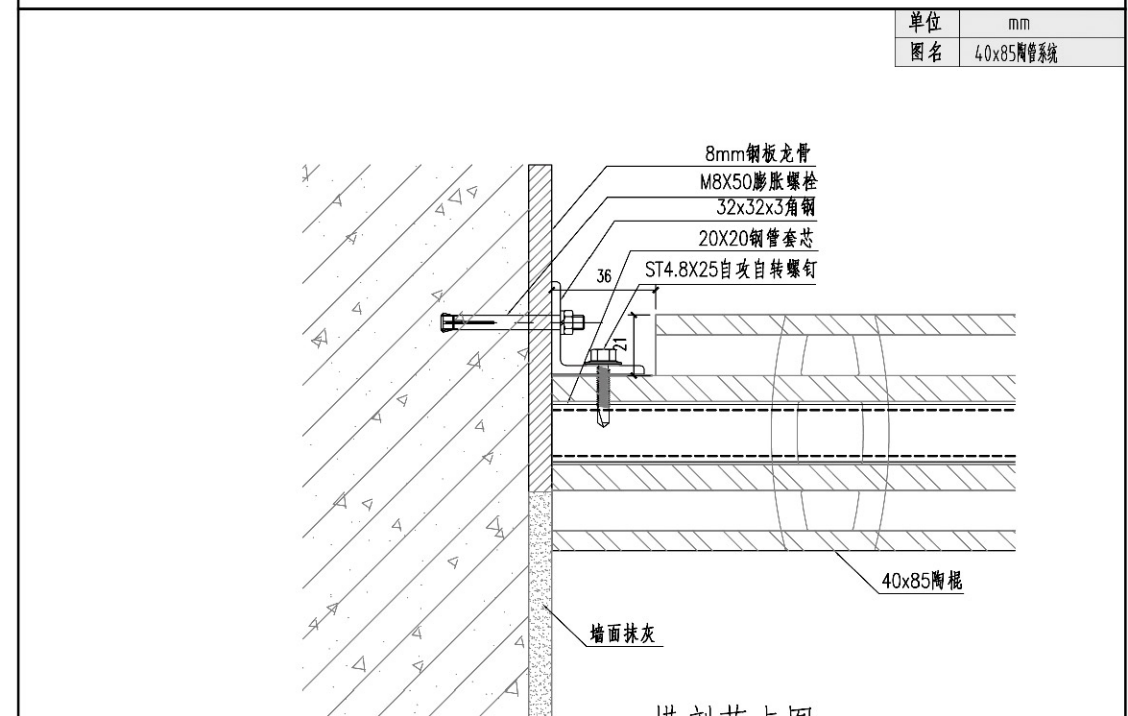

横剖节点图

3.

40x85
陶管系统
安装节点图

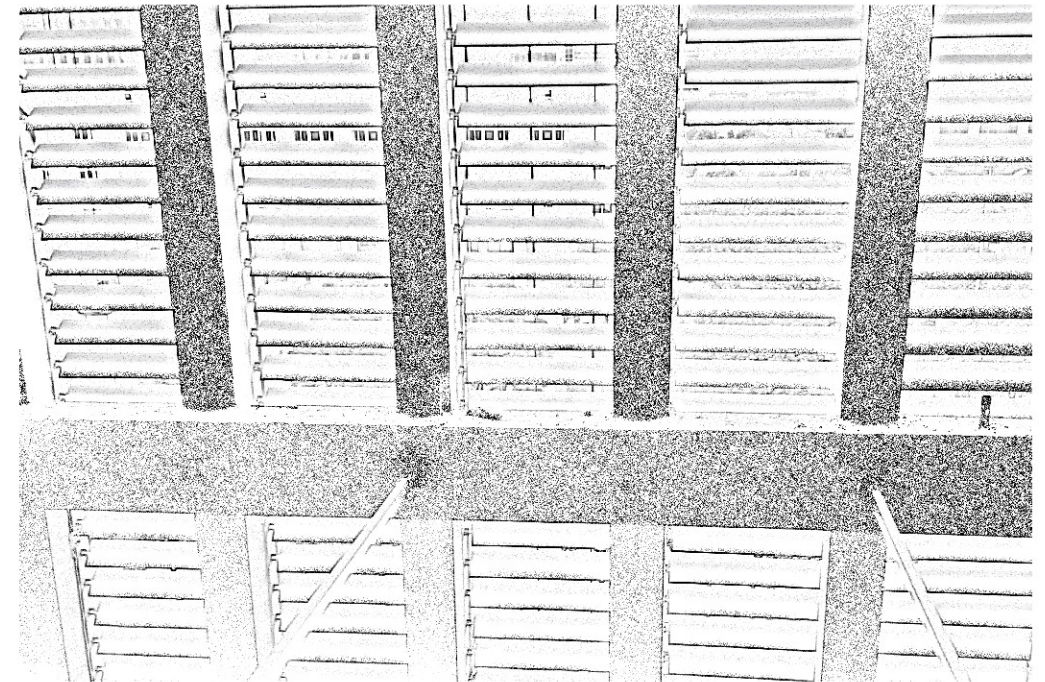
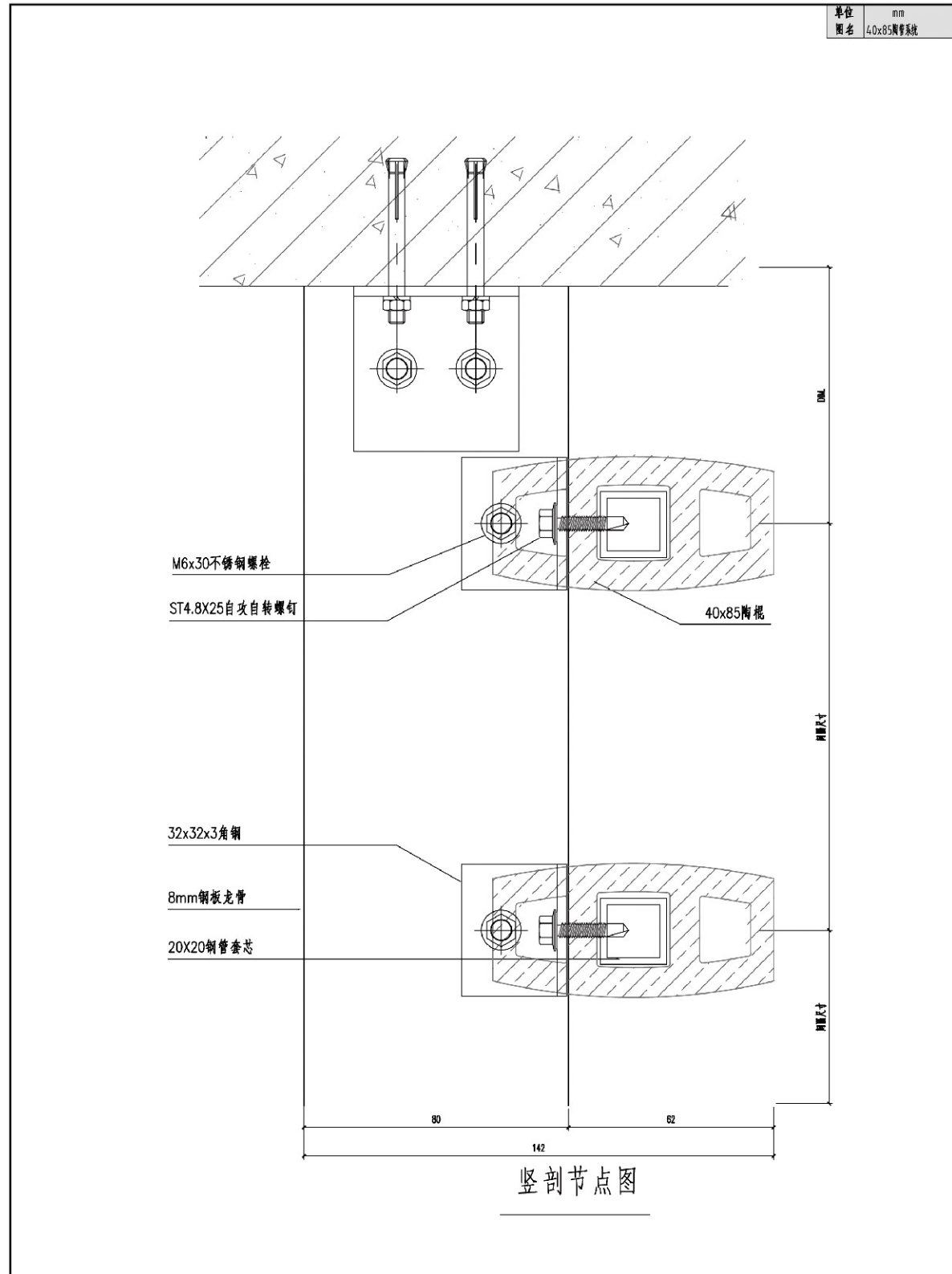

4.

60X60
陶管系统
安装节点图

4.

60x60
陶管系统
安装节点图

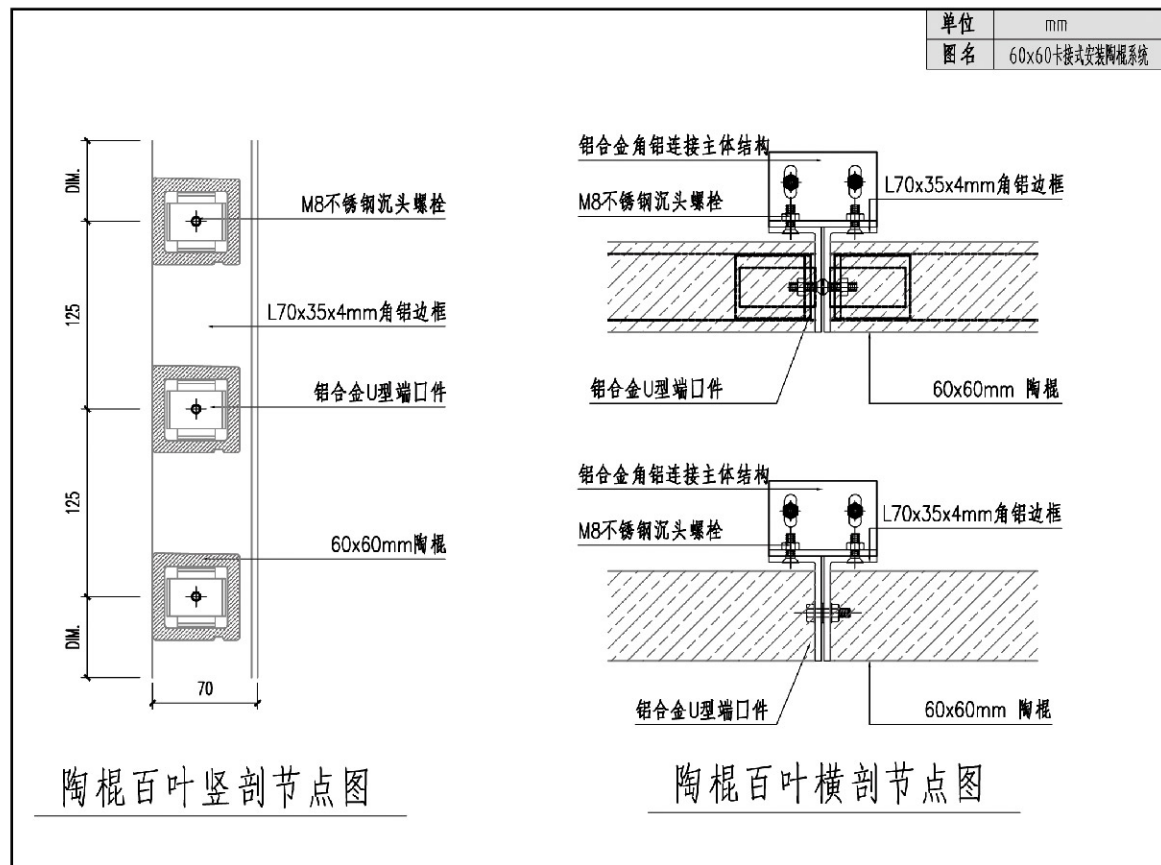

LOPO® 乐普陶板
Terracotta Facade Panels

陶土專家 用心制陶

客户购买的不只是乐普的产品
更希望体现应得的价值与专业的服务
我们用心努力着，所做的一点点
虽些微但不懈怠
期盼离要求越来越近
感谢支持着我们的您……